

TAKSTAR® 得胜



EBS-1C

数码编程控制器

DIGITAL CENTRAL CONTROLLER

使用手册

USER MANUAL

■ 前言

尊敬的用户：

感谢您选购得胜EBS-1C数码编程控制器，为了您能够更好的了解使用本产品，建议您在使用前仔细阅读本说明书。

若存在有疑问或者您有宝贵的建议，可通过拨打得胜官方服务热线4006828333或微信扫描二维码关注得胜官方公众号与我们联系。



■ 产品特性

- ARM+DSP芯片架构，嵌入式RTOS操作系统，采用4.3英寸电容触摸屏，图形化界面，全触控操作。
- 支持PC端编辑定时程序和自定义遥控功能。
- 强大的定时功能，采用自动补偿RTC时钟芯片，定时可精确到秒，自由实现：定时+定点+定曲。
- 采用RS485控制总线，MODE BUS协议，双向通信，可控制周边设备也可以被控制，支持第三方在线控制，方便第三方系统集成（选配）。
- 支持远程寻呼站控制台接入，可实现远程呼叫、音频接入、点播、分区控制、电源控制等操作。
- 消防应急广播功能，支持本机全区触发和外接消防采集器触发，每路外扩消防触发信号均可以自定义触发动作。支持邻层报警。
- 内部集成4G Flash存储芯片，直接焊接在线路板上，永不脱落，安全可靠。可外括TF卡，最大支持32G。
- 采用高速USB2.0接口，电脑可直接访问主机的内存和TF卡，下载音乐文件和程序文件。
- 本机可以浏览歌曲列表和自定义播放列表，全中文显示，长文件名滚动字幕显示，不需要在电脑上生成歌曲列表或编号。
- 支持电脑编程和本机手动编程。支持4套程序，每套程序可编程180个定时点。
- 内部集成FM收音功能。支持预置、自动搜索、手动搜索等功能。
- 一路本地话筒输入，两路AUX输入，四路音频输出，1路远程话筒信号同步输出。
- 远程话筒话筒可单独接入，也可以手拉手连接，三路COM口均可接入，最多可连接十六路远程寻呼话筒。
- 本地话筒支持：混音、自动静音回避，自动减小音量回避，自动触发功放分区，讲话结束后自动恢复

- 支持简易调音台功能，触摸屏模拟调音推子，直观调整每路音源的音量大小。
- 强大的解码能力，支持多种音频编码格式，如MP3、WMA、WAV等。
- 存放的音乐文件不受数量限制只跟存储容量有关。可随意查看的全部的音乐文件，不受任何限制。
- 可控制CD、收音机、分区器、电源时序器、强切电源、消防采集器等周边设备。
- 集成 8 路可编程分区，4 路可编程电源。
- 支持用户密码登录管理，用户可自行设定密码。
- 采用高集成度双核解码ARM+DSP+DAC片上系统。
- 主机自带使用帮助和接线指南，快速入门。
- 可现实，远程话筒，点播、插播等功能，播放结束后均可以自动返回。
- 断电后，重新开机可自动恢复任务执行。

■ 适用范围

适用于校园定时响铃、工厂车间定时响铃、军区部队集结号、高级餐厅音乐广播

■ 包装清单

主机.....	1台
天线.....	1根
电源线.....	1条
说明书.....	1份

■ 技术参数

存储方式：内置4G闪存或外置TF卡

支持音频格式：MP3、WMA、WAV等

收音方式：FM 87.0-108MHz

输出：LINE 500mV Unbalanced

整机音噪比：≥85dB

整机失真度：<0.1%(1KHz)

频率响应：20Hz-20KHz±3dB

可控电源输出：-220V/50Hz <3A

净重：5.1kg

毛重：6.4kg

机身尺寸 (mm)：485x350x90 mm

注：以上数据由得胜实验室测试得到，并拥有最终解释权！

■ 使用说明

前面板

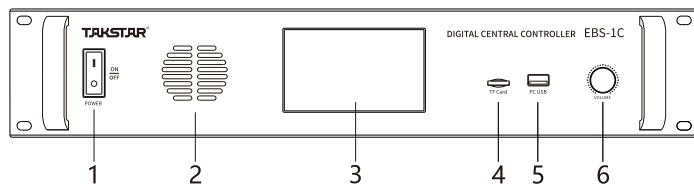

1. 电源开关：打开或关闭电源。
2. 监听口：内置有监听扬声器，用于监听节目的播放内容，用户可以选择开启/关闭。
3. 4.3英寸真彩电容触摸显示屏：显示屏显示系统的所有信息动态和实行触控操作。
4. Tf卡插槽：Tf卡插槽，可插入Tf卡，扩展存储容量，最大可支持32G。
5. USB插口：用USB线与电脑连接，用于下载音乐/定时程序文件到机器。
6. 总音量旋钮：调节总输出音量的大小。

后面板

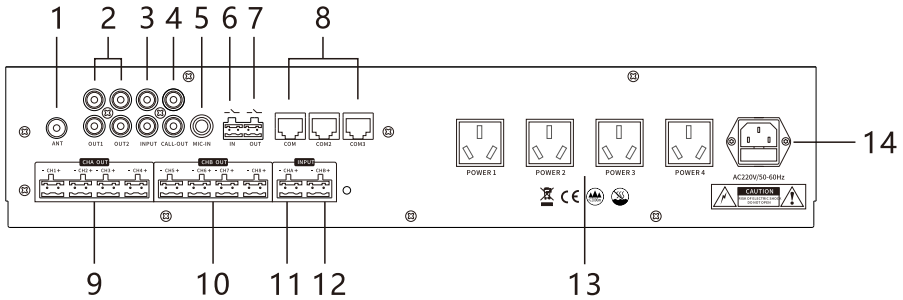

1. 天线接口：无线遥控器天线/FM收音机天线与该接口连接。
2. 音频输出接口：4路音频输出接口与功放音频输入接口连接。
3. 线路输入接口：外音源输入接口，连接外音源输入，如：CD播放器、电脑音频输出等。
4. 程控话筒同步输出接口：输出程控话筒的音频信号，可独立接寻呼功放。
5. MIC输入口：麦克风输入与该接口连接。
6. 干接点短路输入：短路输入接线柱，与其它设备的短路输出接线点连接，触发全区警报播报。
7. 干接点输出：短路输出接线柱，与短路触发设备的短路输入接线点连接，可编程干接点短路输出，可用于触发电源时序器等。
8. Rj45接口：RS485总线接口，通过网线与程控话筒连接或周边设备连接，如受控CD、受控电源时序器、受控分区器等。
9. A组分区输出：1~4分区为A组可编程分区，对应的功率输入为功放A输入。
10. B组分区输出：5~8分区为B组可编程分区，对应的功率输入为功放B输入。
11. 功放A输入：与功放A功率输出接线端连接。
12. 功放B输入：与功放B功率输出接线端连接。
13. 4路可编程电源输出：可编程电源插座，可提供交流220V50Hz，电流不大于3A的电源输出。
14. AC220V电源输入插口：从该接口接入本机器的工作电源，连接时先插入本机器上的插头，再连接电网。

■ 主界面

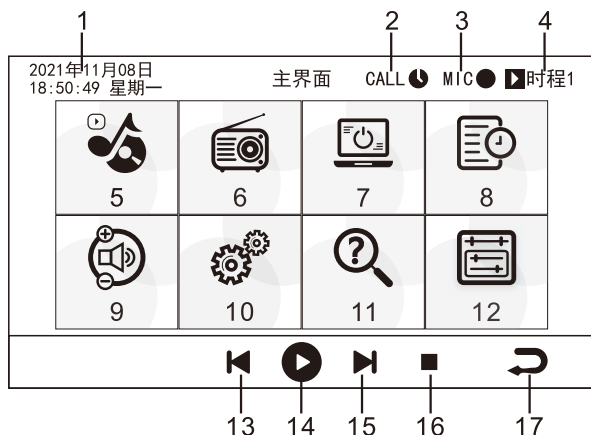

主界面功能说明：

1. 显示系统日期时间。
2. 远程话筒输入提示图标，当远程话筒启动后，该图标变为绿色。
3. MIC信号输入提示图标，带有MIC信号输入时，该图标变为绿色。
4. 显示当前正在运行的模式。
5. 音乐播放器，进入后可以浏览音乐文件、预设要播放的音乐，选择播放模式等。
6. FM调频，进入该应用可以收听FM电台，支持预设电台、手动搜台、自动搜台。
7. 本机分区控制和电源控制，进入该应用可以控制任意一路分区或电源的开启或关闭。
8. 时程编辑，进入该应用可以编辑、修改、查询、检测、删除每一套定时程中的每一个定时任务。
9. 音量调节，进入该应用可以独立调整每一路音源的音量大小和混合后主音量的音量大小。
10. 系统设置，设置系统运行的运行参数，如：语言、监听、消防触发、MIC触发/回避等、遥控等。
11. 使用帮助，本机的简要说明和快速使用指南。
12. 外控管理，通过RS485数据总线外控周边设备。如：受控分区器、受控电源时序器、受控CD机、受控收音等。
13. 切换上一曲按钮，正在播放音乐的状态下，切换上一首音乐。在待机的状态下，自动调用“音乐播放”应用。
14. 播放或暂停按钮，正在播放音乐的状态下，暂停或恢复播放音乐。
15. 切换下一曲按钮，正在播放音乐的状态下，切换下一首音乐。在待机的状态下，自动调用“音乐播放”应用。
16. 停止按钮，停止播放音乐。
17. 返回按钮，返回待机界面。

■ 电脑工具软件

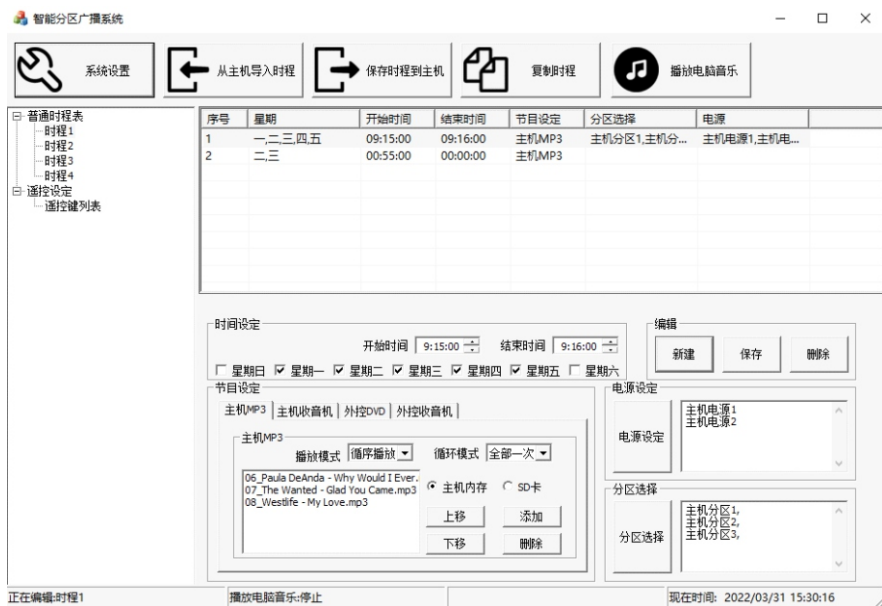

编程步骤说明：

第一步：用USB数据线把主机与电脑连接。

第二步：确定电脑与主机联机后，在上述界面的左侧选择要编辑的时程，在“时程1”，“时程2”，“时程3”，“时程4”中选择。

第三步：在“时间设定”中设定任务时间和日期（勾选星期）。

第四步：在“节目设定”中设定节目内容，如果要定时播放主机内存中MP3的音乐，首先，选择“主机MP3”页，然后点击“添加”，然后选择主机内存对应的移动盘，选择盘中根目录的音乐文件即可。如果要播TF卡中的音乐选择SD卡，选择主机SD卡对应得移动盘，添加盘中根目录得音乐文件即可。

第五步：选择要开启的分区和电源。

第六步：点击“保存”保存当前编辑的定时点任务。（注意每编辑一条记录都有保存）。

第七步：在该软件的窗口顶部点击“保存时程到主机”，选择主机系统主机内存移动盘根目录保存。

第八步：等文件下载完成后，拔出USB线，时程会被自动安装到主机系统中，到此主机会自动按所编辑的时程运行。

■ 可选配件

程控话筒

1. 控制指令采用RS485总线协议，可远距离定点呼叫八分区。
2. 音频信号采用平衡传输，抗干扰能力强，确保声音高保真。有效传输距离达500米以上。
3. 支持AUX输入，可以把本地的音乐向每个分区广播。
4. 支持手拉手连接，可支持16台设备挂接。

面板示意图

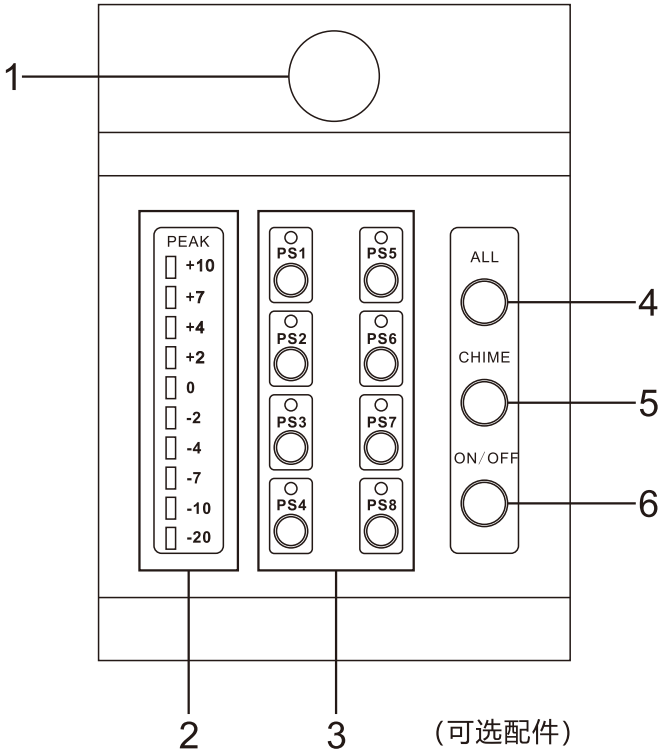

1. MIC杆插座，按住插座弹片插入MIC杆。
2. 10段MIC音量指示灯，用于讲话时，指示MIC的音量的大小。
3. ZONE1~ZONE8：单独控制多路分区，分区打开时指示灯亮，分区关闭时指示灯灭。
4. ALL：一键打开或关闭全部分区。
5. CHIME：播放寻呼提示音。
6. ON/OFF：远程咪的开/关控制键。

背板示意图

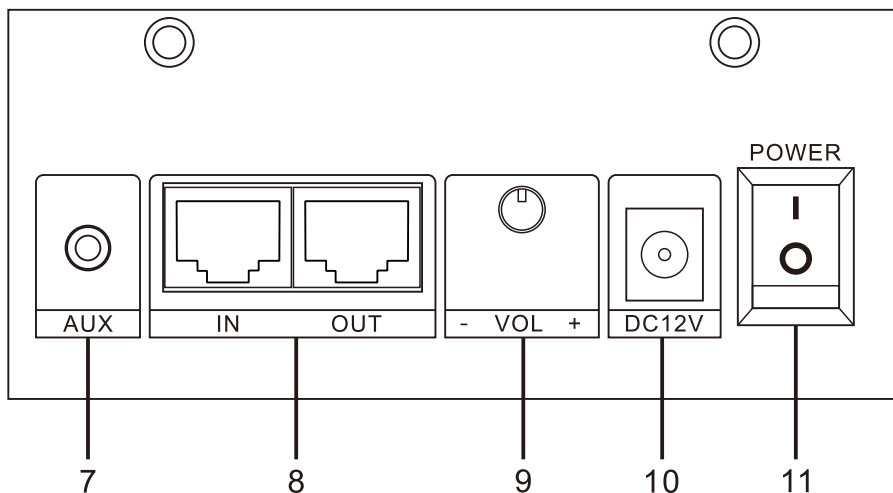

- 7. AUX: 外部音源接入口。
- 8. IN/OUT: RS485线输入输出接口, 可手拉手连接。
- 9. VOL: 话筒咪杆音量调节旋钮。
- 10. DC12V: 外电源直流12V供电。
- 11. POWER: 寻呼器电源开/关。

系统连接图

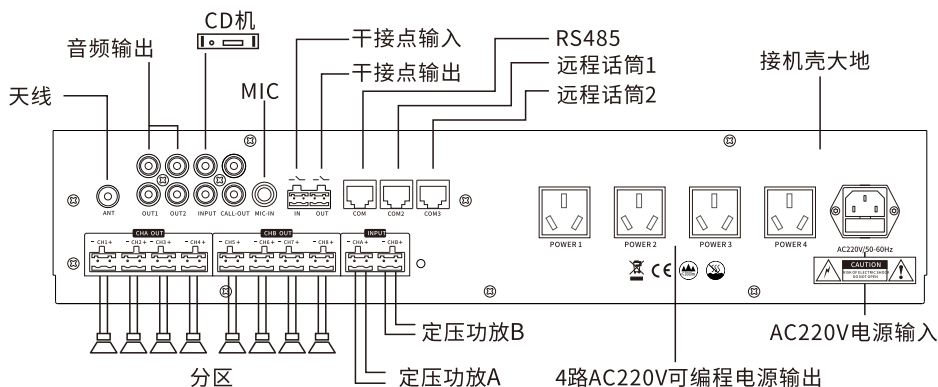

■ 故障检修

症状	原因	排除措施
显示屏没显示	1. 电源未开启 2. 保险丝熔断 3. 市电交流电未来电	1. 开启电源开关 2. 更换保险丝 3. 检查供电
时程事件未如期预期启动	1. 未设定或设定错误	1. 检查是否设定正确
时程事件对应音源输入无放送	1. 未设定对应或设定错误 2. 音源设备未进入预设受控状态 3. 音量调节低	1. 检查是否设定正确 2. 音源设备是否开启,播放媒体是否正确 3. 调节音量
时程事件对应输出接点无启动	1. 未设定对应或设定错误	1. 检查是否设定正确

■ 安全警示

为避免电击、高温、着火、辐射、爆炸、机械危险以及使用不当等可能造成的人身伤害或财产损失，使用本产品前，请仔细阅读并遵守以下事项：

1. 使用产品时请确认所连设备与本产品功率是否匹配以及合理调整音量大小，不要在超过产品功率及大音量下长时间使用，以免造成产品损伤和听力异常；
2. 使用中若发现有异常（如冒烟、异味等），请立即关闭电源开关并拔掉电源插头，然后将产品送经销商检修；
3. 本产品及配件都应放置在室内干燥通风处，请勿长期存放在潮湿、灰尘多的环境，使用中避免靠近火源、雨淋、进水、过度碰撞、抛掷、振动本机及覆盖通风孔，以免损坏其功能；
4. 若产品需要固定于墙壁或天花板上，请确保固定到位，防止因固定强度不足导致产品发生跌落危险；
5. 使用该产品时需遵守相关安全规定，法律法规明确禁止使用场合请勿使用本机，以免导致意外事故；
6. 请不要自行拆机改装或维修，以防止出现人身伤害，如有问题或服务请联系当地经销商跟进处理。

■ PREFACE

Dear Customer,

Thank you for purchasing Takstar EBS-1C Digital Central Controller. In order to better understand and use the product, please read this manual carefully.

If you have any questions or suggestions, please contact our local dealer.

■ FEATURES

- ARM+DSP chip architecture, embedded real-time operating system (RTOS), 4.3-inch capacitive touch screen, graphical interface, full touch operation.
- Supports PC-side editing of timing programs and custom remote control functions.
- Powerful timing function, using real-time clock (RTC) chip with automatic compensation to achieve accuracy down to the second.
- Adopts RS485 control bus, MODE BUS protocol, two-way communication, can control peripheral devices and can also be controlled by third-party online devices for easy third-party system integration (optional).
- Supports remote paging station access, which can achieve remote call, audio access, on-demand broadcast, zone control, power control and other operations.
- Fire emergency broadcast function, supports local triggering and triggering by external fire alarm matrix, and triggering actions can be customized for each external trigger signal. Supports adjacent zone alarm.
- Built-in 4GB flash memory securely soldered on the circuit board. Expandable with external TF card up to 32GB.
- High-speed USB2.0 interface, through which a computer can directly access the host's memory and TF card, upload and download music files and program files.
- Browse and customize playlists locally, view file names in rolling Chinese/English format. No need to generate playlist or number songs on a computer.
- Programmable locally or on computer. Supports 4 sets of programs, each can contain 180 timed events.

- Integrated FM radio function. Supports preset, automatic or manual search of stations.
- One local mic input, two AUX inputs, four audio outputs, and one remote mic signal synchronous output.
- Remote mics can be connected on all three COM ports, either individually or daisy-chained, supporting a maximum of 16 remote paging mics.
- Local mic settings: mixing, auto evade, evade level, automatic zone triggering and recover time; all configurable in system Settings.
- Edit, browse and run temporary timed tasks locally, quickly setting up various running tasks.
- Supports simple mixer function, intuitive emulated fader on touch screen to adjust the volume of each audio source.
- Powerful decoding capability, supports multiple audio encoding formats, such as MP3, WMA, WAV, etc.
- No restriction on the number of music files you can store, as long as the capacity allows. View all music files at will without restrictions.
- Can control peripheral devices such as CD player, radio, zone selector, power sequencer, override power, fire alarm matrix and so on.
- Integrated with 8CH programmable zones, 4CH programmable power supply.
- Supports password login management, customizable user password.
- Adopts highly integrated dual-core decoding ARM+DSP+DAC system-on-chip.
- Help manual and wiring guide on host unit for quick start.
- Achieve remote paging, on-demand broadcast, spot broadcast, and automatic recovery after playback.
- Reboot to automatically resume task execution after power outage.

■ APPLICATIONS

Timed messages/signals in schools, factories and the military, and music broadcast in high-end restaurants

■ PACKING LIST

- 1 * Controller (Host Unit)
- 1 * Antenna
- 1 * Power Cord
- 1 * User Manual

■ SPECIFICATIONS

Storage Method: built-in 4GB flash memory or external TF card

Supported Audio Formats: MP3, WMA, WAV

Radio Mode: FM 87.0-108MHz

Output: LINE 500mV Unbalanced

Overall S/N Ratio: ≥ 85 dB

Overall Distortion: $< 0.1\%$ (1KHz)

Frequency Response: 20Hz-20KHz ± 3 dB

Controllable Power Output: -220V/50Hz < 3 A

Net Weight: 5.1kg

Gross Weight: 6.4kg

Dimensions (mm): 485x350x90 mm

Note: The above data are measured by Takstar laboratory which has the final interpretation right!

■ DESCRIPTIONS

FRONT PANEL

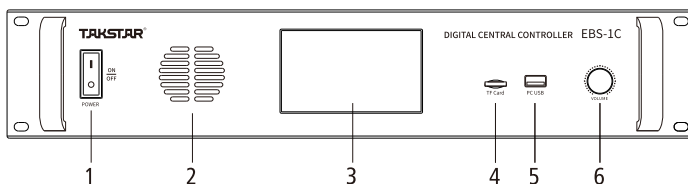

1. Power Switch: Turns on/off the power.
2. Monitor Opening: Monitor speaker inside for monitoring the content of the program; can be turned on/off.
3. 4.3-inch True-Color Capacitive Touch Screen: Shows all the system status and info; for touch control operation.
4. TF Card Slot: for TF card installation, expandable up to 32GB.
5. USB Socket: Connect with a computer by USB cable for downloading music/schedule files to the machine.
6. Master Volume Knob: Adjusts the overall output volume.

REAR PANEL

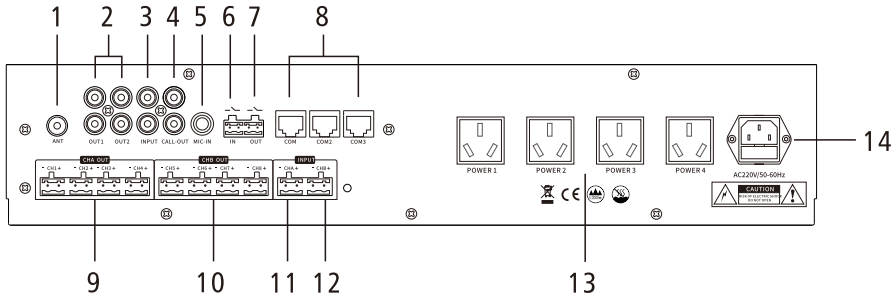

1. Antenna Interface: for connecting remote control/FM radio antenna.
2. Audio Output: 4CH audio outputs for connecting to the audio inputs of a power amplifier.
3. Line Input: for connecting external audio source such as: CD player, computer audio output, etc.
4. Synchronous Output for Programmable Mic: Outputs the audio signal of the programmable mic, can be independently connected to a paging amplifier.
5. MIC Input: for connecting mic.
6. Dry Contact Short-Circuit Input: Short-circuit input terminal, for connecting to the short-circuit output terminal of other equipment to trigger zone alarm broadcast.
7. Dry Contact Output: Short-circuit output terminal, for connecting to the short-circuit input terminal of a short-circuit trigger device; programmable, can be used to trigger power sequencer, etc.

- 8. RJ45 Interface: RS485 bus interface, for connecting to a programmable mic or peripheral equipment (e.g., controlled CD player, controlled power sequencer, controller zone selector) using a network cable.
- 9. Group A Zone Output: Group A contains programmable zones 1~4; its respective power input is CHA power amp input.
- 10. Group B Zone Output: Group B contains programmable zones 5~8; its respective power input is CHB power amp input.
- 11. CHA Power Amp Input: for connecting to the power output terminal of power amp A.
- 12. CHB Power Amp Input: for connecting to the power output terminal of power amp B.
- 13. 4CH Programmable Power Output: Programmable power sockets, can provide AC 220V50Hz with no more than 3A power output.
- 14. AC220V Power Input Socket: for connecting to the power supply for this machine.
Insert the plug on the machine first, then connect to the mains.

■ HOME SCREEN

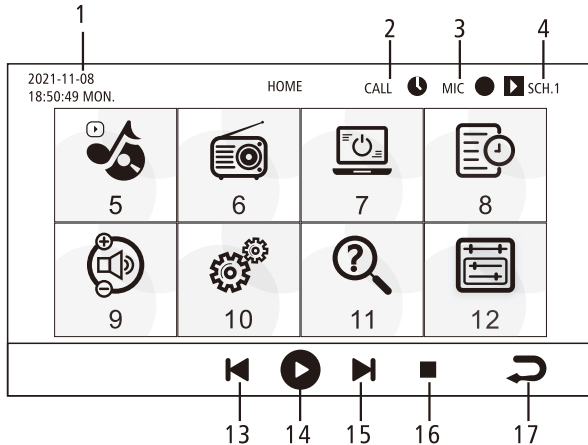

Home screen functions:

1. System date and time.
2. Remote mic input icon, which turns green when the remote mic is activated.
3. MIC signal input icon, which turns green when there is MIC signal input.
4. Current running mode.
5. Music player, where you can browse music files, preset which music to be played, and select the playback mode.
6. FM radio, where you can listen to FM radio stations, use preset stations, manually or auto search stations.
7. Zone and power control, where you can turn on/off any zone/power.
8. Schedule editing, where you can edit, modify, view, run, or delete events inside each schedule.
9. Volume adjustment, where you can adjust the volume of each audio source and the mixed master volume.
10. System settings, where you can set the operating parameters, such as: language, monitoring, fire alarm trigger, MIC trigger/evasion, remote control, etc.
11. Help manual, which contains a brief introduction and a quick start guide.
12. External device management. External controlled peripherals are connected through RS485 data bus, e.g., controlled zone selector, controlled power sequencer, controlled CD player, controlled radio.
13. Previous track button, which can switch to the previous song when playing music. In standby mode, click to automatically invoke Music player.
14. Play/Pause button, which can pause or resume playback when playing music.
15. Next track button, which can switch to the next song when playing music. In standby mode, click to automatically invoke Music player.
16. Stop button, which can stop music playback.
17. Return button, which can return to the standby interface.

■ ZONE BROADCAST SYSTEM SOFTWARE

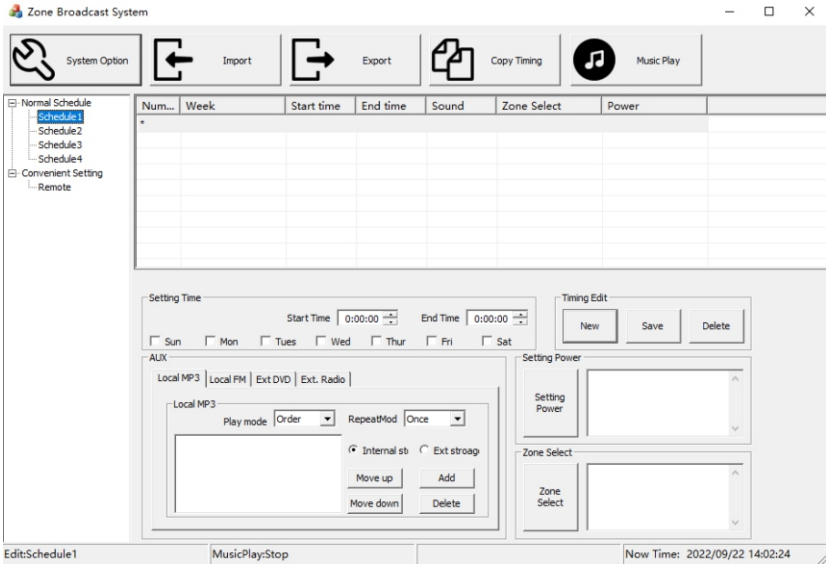

Schedule editing steps:

Step 1: Connect the host to a computer with a USB cable.

Step 2: When connected successfully, select which schedule to edit on the left column of the above interface, from "Schedule 1", "Schedule 2", "Schedule 3", to "Schedule 4".

Step 3: Set the task time and date in "Setting Time" (check which day of the week).

Step 4: Set the program content in "AUX". If you want to play MP3 files stored in the host memory, first, select the "Local MP3" tab, then click "Add", select the mobile disk corresponding to the host memory, and select the music files in the root directory of the disk. If you want to play music files in the TF card, select the TF card, then select the mobile disk corresponding to the host SD card, and add the music files in the root directory of the disk.

Step 5: Select which zone and power you want to turn on.

Step 6: Click "Save" to save the editing timed task. (Remember to save each record after editing.)

Step 7: Click "Export" at the top of the window, and select the root directory of the host system memory disk to save.

Step 8: After the file is downloaded, unplug the USB cable. The schedule will be automatically installed in the host system, and the host will run the edited schedule accordingly.

OPTIONAL ACCESSORIES

PROGRAMMABLE MICROPHONE

1. The control command uses RS485 bus protocol, which can call eight zones from somewhere afar.
2. The audio signal utilizes balanced transmission, with strong anti-interference capability to ensure high audio fidelity. Effective transmission distance is more than 500 meters.
3. Supports AUX input, can broadcast local music to each zone.
4. Supports daisy chain connection, can directly hook up with 16 device.

CONTROL PANEL

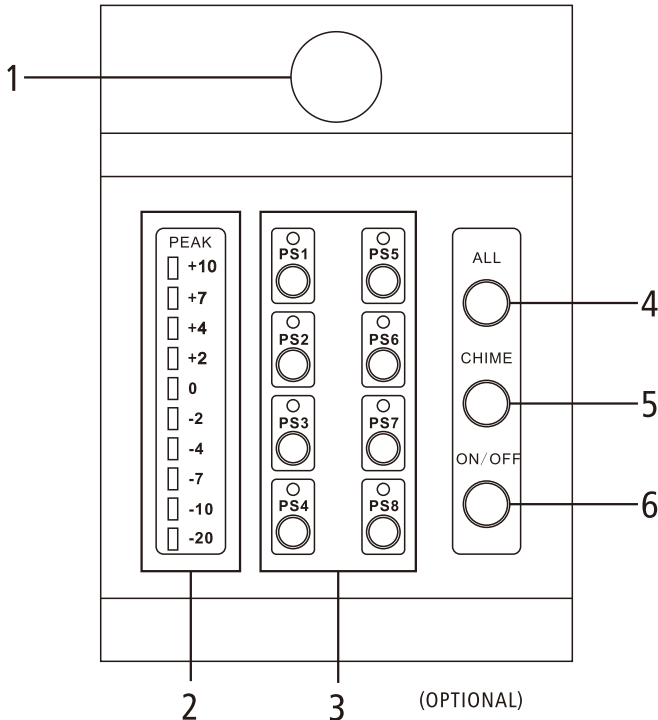

- 1. MIC socket: Press and hold the socket tab to insert MIC pole.
- 2. 10-Segment MIC volume indicator: Used to indicate the mic volume level when speaking.
- 3. ZONE1~ZONE8: Individual control for each zone. The indicator lights up when the zone is turned on, and off when the zone is turned off.
- 4. ALL: Click to turn on/off all zones.
- 5. CHIME: Play the paging tone.
- 6. ON/OFF: Turns on/off the remote mic.

REAR PANEL

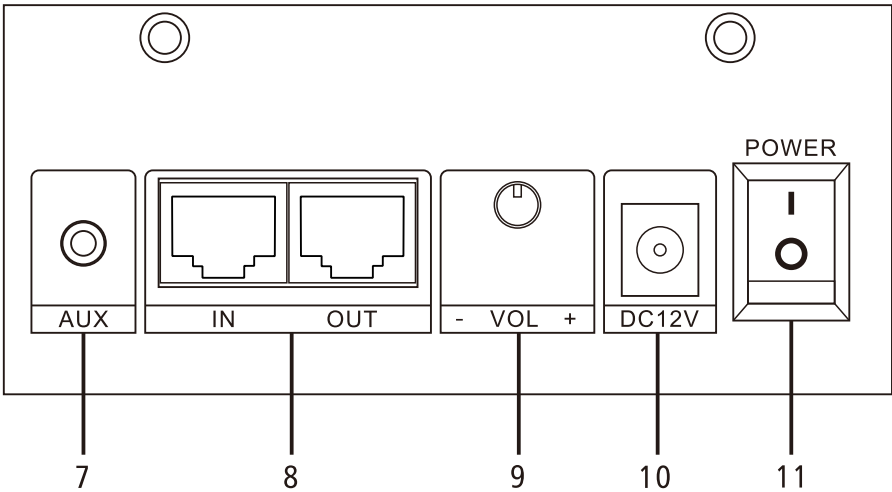

- 7. AUX: External audio source input.
- 8. IN/OUT: RS485 cable input and output ports, which supports daisy chain connection.
- 9. VOL: Mic volume adjustment knob.
- 10. DC12V: External 12V power supply input.
- 11. POWER: Pager power switch, on/off.

SYSTEM DIAGRAM

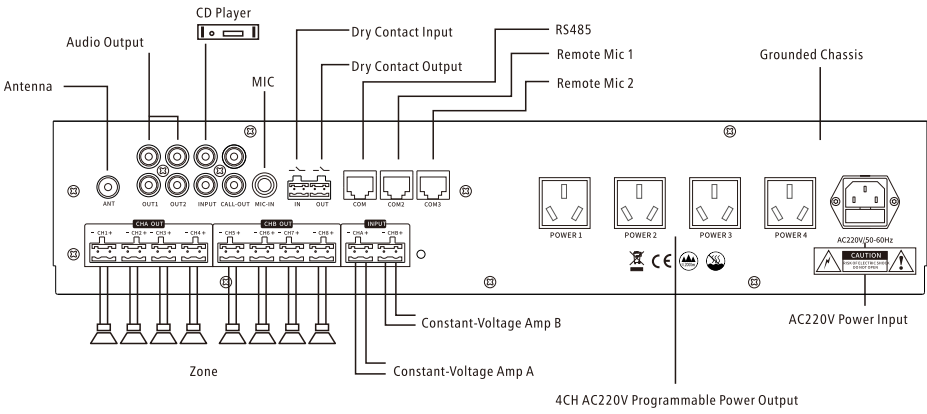

TROUBLESHOOTING

ISSUES	CAUSES	MEASURES
Display does not show anything	<ol style="list-style-type: none"> 1. Power is not turned on 2. Fuse is blown 3. Mains AC outage 	<ol style="list-style-type: none"> 1. Turn on the power switch 2. Replace the fuse 3. Check the mains power supply
Scheduled event did not start as expected	<ol style="list-style-type: none"> 1. Not set or set incorrectly 	<ol style="list-style-type: none"> 1. Check if the settings are correct
No playback from the audio source corresponding to the scheduled event	<ol style="list-style-type: none"> 1. Not linked or set incorrectly 2. The audio source device is not in the preset controlled state 3. Volume is low 	<ol style="list-style-type: none"> 1. Check if the settings are correct 2. Whether the audio source device is on and whether the playback media is correct 3. Adjust the volume
Output contact corresponding to the scheduled event is not activated	<ol style="list-style-type: none"> 1. Not linked or set incorrectly 	<ol style="list-style-type: none"> 1. Check if the settings are correct

■ CAUTIONS

To avoid electric shock, overheat, fire, radiation, explosion, mechanical risk and injury or property loss due to improper use, please read and observe the following items before use:

1. Please check if the power of the connected equipment matches with that of this product before operation. Adjust the volume to proper level during operation. Do not operate at over-power or high-volume level for extended time to avoid product malfunction or hearing impairment.
2. If there is any abnormality during use (e.g., smoke, strange odor), please kill the power switch and unplug from power source, then send the product to the dealer for repair.
3. Keep this product and its accessories in a dry and ventilated area. Do not store in a humid or dusty area for extended time. Keep away from fire, rain, liquid intrusion, bumping, throwing, vibrating, or from blocking any ventilation openings, to prevent malfunction.
4. The product must, when installed on walls or ceilings, be fixed firmly in place at adequate strength to prevent from falling.
5. Please abide by safety rules during operation. Do not use the product in places prohibited by laws or regulations to avoid accident.
6. Do not disassemble or repair the product by yourself to avoid injury. If you have any questions or require any services, please contact our local dealer.

注意事项:

1. 本单为保修凭证, 请用户妥善保管, 如有遗失, 恕不保修或退换。
2. 保修期限制: 购买之日起十二个月内。
3. 除了不可抗力事件损坏外, 由本公司负责, 免费维修。
4. 如属保管不善或使用不当造成的损坏, 维修点将酌情收费。
5. 擅自拆卸维修者, 不予保修。
6. 以上保修条款仅限于中国市场适用 (不含港澳台地区)。

产品服务保证书

姓名: _____ 电话: _____ 地址: _____

商品: _____ 型号: _____ 购买日期: _____ 年 ____ 月 ____ 日

维修记录栏 (由维修员填写)	维修员签名	日期

◆ 广东得胜电子有限公司 ◆ 电话: 400-6828-333 ◆ 地址: 广东省惠州市博罗县龙溪街道富康一路2号



扫一扫，了解更多产品
Scan for more
product information

广东省电声工程技术研究开发中心 广东得胜电子有限公司制造

地址：广东省惠州市博罗县龙溪街道富康一路2号

服务热线：400 6828 333 传真：0752 6383950

邮箱：xs@takstar.com

网址：www.takstar.com

Guangdong Takstar Electronic Co., Ltd.

Address: No. 2 Fu Kang Yi Rd., Longxi Boluo

Huizhou, Guangdong 516121 China

Tel: 86 752 6383644 Fax: 86 752 6383952

Email: sales@takstar.com

Website: www.takstar.com