

TAKSTAR® 得胜

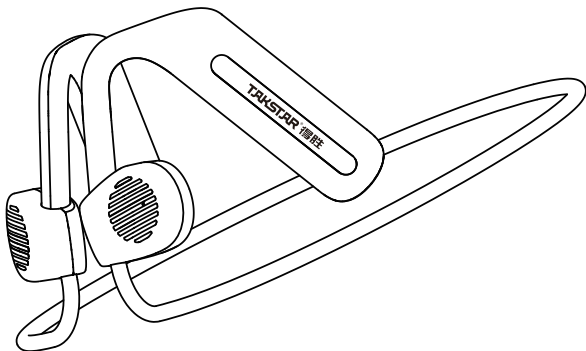

LA200W

开放式无线耳机

Open-Ear Wireless Headphones

使用手册 | User Manual

LA200W 开放式无线耳机

■ 前言

尊敬的用户：

感谢您选购得胜LA200W开放式无线耳机，为了您能够更好地了解使用本产品，建议您在使用前仔细阅读本使用手册。

若存在有疑问或者您有宝贵的建议，可通过拨打得胜官方服务热线400 6828 333或微信扫描二维码关注得胜官方公众号与我们联系。



■ 产品特性

- 全新 \varnothing 16.2mm复合膜单元，还原声音本质；
- V5.4版本无线连接，低功耗、抗干扰性强，连接更快更稳定；
- 3种音效模式，随心选择个人的风格喜好；
- 开放式聆听方式，实时感知环境音，户外运动更安全；
- 防水设计，无惧汗雨，满足运动使用需求；
- 支持快速充电，充电5分钟，持续使用约2小时；
- 长时间的续航时间，满电可持续使用约15小时；
- 符合人体工学的贴耳设计，机身轻巧，佩戴舒适且稳固。

■ 适用范围

音乐鉴赏、户外运动等场合

■ 标准配置

- 耳机 1只
- 充电线 1条
- 使用手册 1份

■ 技术参数

耳机参数

- 无线版本: V5.4
- 单元直径: $\varnothing 16.2\text{mm}$
- 单元阻抗: $16\Omega \pm 15\%$
- 频率响应: 20Hz-20kHz
- 峰值功率: 70mW
- 额定功率: 50mW
- 电池容量: 200mAh
- 充电规格: DC 5V/600mA
- 充电时间: 约30分钟
- 续航时间: 约15小时
- 产品重量: 32g
- 传输范围: >10米 (无障碍空旷空间)

麦克风参数

- MIC类型: 硅麦
- 灵敏度: $-42 \pm 3\text{dB}$
- 指向性: 全指向

注:

- 1) 以上数据由得胜实验室测试得到,并拥有最终解释权!
- 2) 充电时间和使用时间可能会因使用状况存在差异。
- 3) 传输范围将视设备之间的障碍物、周围的磁场、静电等因素而变化。
- 4) 防水设计是防止从各方向水溅入耳机, 不包括耳机透气孔、麦克风孔。

LA200W 开放式无线耳机

■ 功能示意

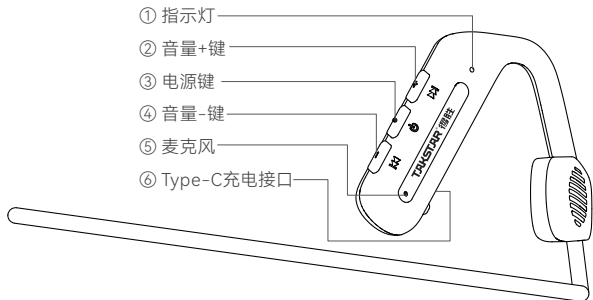

■ 佩戴示意图

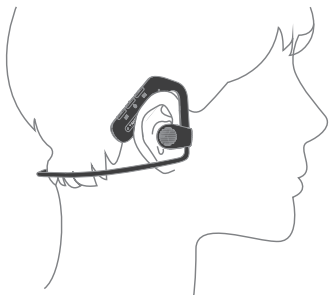

■ 使用说明

一、开机/关机

开机: 长按电源键2秒开机。

关机: 开机状态下, 长按电源键2秒关机。

二、无线连接

首次使用本机时, 需要与手机或无线播放设备配对连接, 步骤如下:

1. 长按耳机电源键2秒开机后, 耳机自动进入搜索配对状态, 指示灯绿橙灯闪烁。
2. 打开智能设备“设置”菜单, 找到无线连接列表, 搜索“TAKSTAR LA200W”进行连接, 连接成功后伴随语音提示。
3. 支持一拖二使用, 若需同时连接AB两台设备使用时, 则需提前将AB两台设备都与耳机完成配对, 当AB两台设备都与耳机成功连接时, 即可一拖二使用。如需切换播放音频的设备时, 则需将当前播放音频的A设备暂停, 再将B设备控制播放即可。

注:

- 1) 已配对设备, 耳机开机后, 将自动回连最后一次成功连接过的智能设备。
- 2) 无设备连接, 或与设备断开连接后, 耳机超过回连时间5分钟, 将自动关机。
- 3) 如需重新连接其他设备, 可在耳机关机状态下, 长按电源键5秒进入配对模式, 直至听到配对提示音后, 松开按键即可。
- 4) 若配对异常, 可同时长按耳机音量+和音量-键, 直至听到提示音后松开按键, 耳机自动关机, 恢复出厂设置。
- 5) 一拖二使用, 无论当前是哪台设备正在播放音频, 来电时都会提示来电铃声。

三、按键操作

1. 媒体控制



注: 耳机具有记忆功能, 重新开机使用时, 默认保持关机前的设置状态。

2. 通话控制

① 双方通话

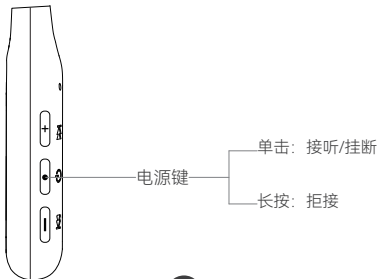

LA200W 开放式无线耳机

② 三方通话

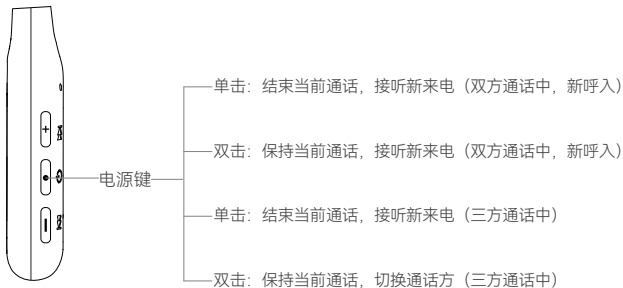

四、低电提醒

耳机使用过程中, 低电时会伴随低电提示音, 请及时使用Type-C充电线连接适配器为耳机充电。充电状态下, 指示灯橙灯长亮; 电量充满后, 指示灯绿灯长亮。
注: 充电必须使用5V适配器, 勿使用大于5V适配器进行充电, 可能会造成损坏。

五、语言切换

开机未连接状态下, 同时长按耳机电源键和音量+键2秒, 可切换中/英文提示音。

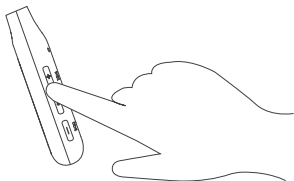

■ 安全使用说明

为了您有一个安全与舒适的体验，请仔细阅读并遵守以下事项：

1. 为了避免听力受损，请务必在连接耳机前将播放设备音量调小。在将耳机佩戴入耳内/耳上之后，再逐步调大至您聆听舒适的音量。噪音是以分贝 (dB) 为计量单位的，外界任何85分贝及以上的噪音都会导致听力逐渐受损。
2. 请注意您的使用习惯。音量和时间对听力损失的影响成正比的关系，音量越大，您的聆听时间越短；音量越舒适，您聆听的时间越长。长时间使用较高的音量会对您的听力造成损伤。

以下分贝 (dB) 表对某些常见声音进行比较，并列出了它们可能对听力的潜在危害等级。

声音来源	噪声等级	听力影响
细声低语	30dB	非常安静
安静的办公室	50-60dB	舒适的听力级别在60dB以下
吸尘器/吹风机	70dB	有一定入侵性，造成干扰妨碍电话交谈
食物料理机	85-90dB	85dB是开始造成听力受损 (连续8小时)的级别
垃圾清理机 混凝土搅拌机	100dB	建议无保护措施而暴露在90-100dB声音 之下的时间不要超过15分钟
电锯/电钻	110dB	经常暴露于超过100dB的声音1分钟以上 会有听力受损的风险
摇滚音乐会 (因情况而异)	110-140dB	感觉疼痛的阈值在120dB左右开始

LA200W 开放式无线耳机

■ 维护及保养

1. 请储存于干燥洁净环境，使用中避免液体进入耳机内部、跌落或碰撞，以免损坏；
2. 勿在高温高湿的场所长时间使用耳机，容易造成耳机损坏或降低使用寿命；
3. 耳机在放置时要避免与强磁体接触，以免耳机的恒磁体去磁，使耳机的灵敏度降低而影响影响耳机音色；
4. 勿使用烈性化学制品、清洁剂，清洁耳机；
5. 不要用尖锐物品在产品表面刮蹭，以免损坏外壳、影响外观；
6. 耳机长时间不使用时，应存放在干燥清洁的地方，避免在温度过高或过度潮湿的场所保管或使用。

■ 注意事项

⚠ 危险

为确保您的人身安全，请勿将该耳机佩戴或放置在离心脏起搏器过近的位置（小于10cm）。	⊘ 禁止
请勿将线材插头插入电源插座。	⊘ 禁止
为了您与其他交通参与者的安全，驾驶车辆、骑自行车或马路上行走时，请勿使用耳机。	⚠ 执行
请勿将耳机靠近明火或置于火中，以免发生爆炸。	⊘ 禁止

⚠ 警告

儿童应在成人监督下使用本产品，本产品并非玩具。	⚠ 执行
使用该产品时需遵守相关安全规定，法律法规明确禁止使用场合请勿使用本产品，以免导致意外事故。	⚠ 执行

■ 安全警示

为避免电击、高温、着火、辐射、爆炸、机械危险以及使用不当等可能造成的人身伤害或财产损失，使用本产品前，请仔细阅读并遵守以下事项：

1. 使用产品时请确认所连设备与本产品是否匹配以及合理调整音量大小，不要在超过产品功率及大音量下长时间使用，以免造成产品异常；
2. 使用中若发现有异常（如冒烟、异味等），请立即关闭电源开关并拔掉电源插头，然后将产品送售后服务网点检修；
3. 本产品及配件都应放置在室内干燥通风处，请勿长期存放在潮湿、灰尘多的环境，使用中避免靠近火源、雨淋、进水、过度碰撞、抛掷、振动本机及覆盖通风孔，以免损坏其功能；
4. 若产品需要固定于墙壁或天花板时，请确保固定到位，防止因固定强度不足导致产品发生跌落危险；
5. 使用该产品时需遵守相关安全规定，法律法规明确禁止使用场合请勿使用本产品，以免导致意外事故；
6. 请不要自行拆机改装或维修，以防止出现人身伤害，如有问题或服务需求请联系当地售后服务网点跟进处理。

■ 环保说明

产品中有毒有害物质或元素的名称及含量标识表

部件名称	有毒有害物质或元素					
	铅 (Pb)	汞 (Hg)	镉 (Cd)	六价铬 (Cr(VI))	多溴联苯 (PBB)	多溴二苯醚 (PBDE)
塑料部件	○	○	○	○	○	○
金属部件	×	○	○	○	○	○
电路板组件	×	○	○	○	○	○
线缆	×	○	○	○	○	○



本表格依据SJ/T 11364的规定编制

○: 表示该有害物质在该部件所有均质材料中的含量均在GB/T 26572规定的限量要求以下。

×: 表示该有害物质至少在该部件的某一均质材料中的含量超出GB/T 26572规定的限量要求。

此标志为产品的环保使用期限标志,
且此环保使用期限只适用于产品正常工作的温度和湿度等条件。

电池部分的环保使用期限为5年。



■ 关于图标含义解释

 根据RL2004/108/EG和European Low Voltage Directive (欧洲低电压指令) RL2006/95/EG的测试结果表明, 本产品符合欧共体关于电磁兼容性的成员国法律整合的指令中所规定的限值。

 未经合规方明确批准的变更或修改可能会使用户失去操作设备的权限。此设备符合FCC规则第15条部分的要求。操作须符合以下两个条件:

- (1) 此设备可能不会造成有害干扰,
- (2) 此设备必须接受接收到的任何干扰, 包括可能导致意外操作的干扰。

LA200W 开放式无线耳机



此符号表示，根据WEEE指令(2012/19/EU)和国家法律，由于这种类型的废弃物会有潜在的有害物质，可能对环境 and 人类健康产生负面影响，所以本产品不应与您的家庭垃圾一起处置，应将本产品交由授权的电气和电子设备 (WEEE) 回收站回收。同时，您在正确处理本产品的同时将有助于自然资源的有效利用。如需了解更多有关您可以在何处放置废物回收设备的信息，请联系您当地的城市办事处、废物管理局或家庭废物处理服务部门。

■ 关于本使用手册

本使用手册中内容符合截止印刷之日的技术规格。由于得胜公司会不断改进产品，本使用手册可能不符合您的特定产品的技术规格。要获取最新版使用手册，请访问得胜官网，然后下载使用手册文件。技术规格、设备或另售的附件在各个地区可能有所不同，如有问题请与当地得胜销售网点确认。如需更多支持和深层产品信息，请浏览得胜官方网站：<https://www.takstar.com>

版权所有 ©2024 得胜。得胜、TAKSTAR及其各自标志是广东得胜电子有限公司在中国和/或其他国家/地区的注册商标或商标。所有其它商标均是其各自所有者的财产。

LA200W Open-Ear Wireless Headphones

■ Preface

Dear Customer,

Thank you for purchasing Takstar LA200W Open-Ear Wireless Headphones.

To better understand and use the product, please read this manual thoroughly. If you have any questions or suggestions, please contact our local sales outlet.

■ Features

- New Ø16.2mm composite diaphragm restores the essence of sound.
- Wireless V5.4 low-power, anti-interference, quick-pairing connection.
- Three sound modes to fit your personal style preference.
- Open-ear design allows ambient sound awareness for safer outdoor exercise.
- Waterproof design handles sweat and rain for active use.
- Supports fast charging – 5 minutes gives around 2 hours playback.
- Extended battery life, about 15 hours playtime on a full charge.
- Ergonomic, lightfit design is comfortable and secure.

■ Applications

Music appreciation and outdoor activities.

■ Package Contents

- 1 × Headphones
- 1 × Charging Cable
- 1 × User Manual

■ Specifications

Headphones

- Wireless Version: V5.4
- Driver Diameter: Ø16.2mm
- Impedance: $16\Omega \pm 15\%$
- Frequency Response: 20Hz-20kHz
- Peak Power: 70mW
- Rated Power: 50mW
- Battery Capacity: 200mAh
- Charging Specs: DC 5V/600mA
- Charging Time: Approx. 30 minutes
- Battery Life: Approx. 15 hours
- Product Weight: 32g
- Transmission Range: >10 meters (unobstructed open space)

Microphone

- Mic Type: MEMS Mic
- Sensitivity: $-42 \pm 3\text{dB}$
- Polar Pattern: Omnidirectional

Note:

1. The above data are measured by Takstar laboratory, and Takstar has the final interpretation right!
2. Charging time and battery life may vary depending on usage conditions.
3. Transmission range may vary due to obstacle, magnetic field, static, receiving sensitivity, antenna performance, operating system, etc.
- 4) The waterproof design is intended to prevent water splashes from entering the earphones from all directions, excluding the earphone vents and mic holes.

■ Function Descriptions

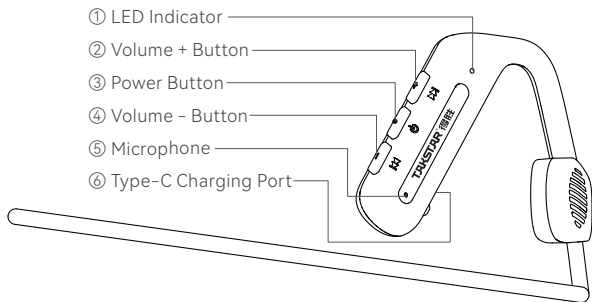

■ Wearing Method

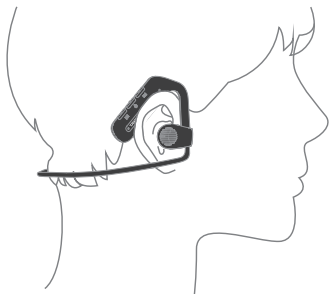

■ Operating Instructions

A. Power On/Off

Power On: Press and hold power button for 2 seconds.

Power Off: When powered on, press and hold power button for 2 seconds.

B. Wireless Connection

When using the headphones for the first time, you need to pair and connect them with your mobile phone or wireless playback device. Follow the steps below:

1. Press and hold power button on headphones for 2 seconds to turn them on. The headphones will enter pairing mode automatically, and the indicator light will blink green and orange.
2. Open Settings menu on your smart device and find wireless connection list. Search for TAKSTAR LA200W and connect to it. You will hear a voice prompt when connected successfully.
3. The headphones support dual connection. If you want to connect to two devices (A and B) simultaneously, you need to pair both devices with the headphones beforehand. Once both devices are successfully connected to the headphones, you can switch between them for audio playback. To switch to device B, pause audio playback on device A and control playback on device B.

Note:

1. The headphones will automatically reconnect to previously paired smart device.
2. If there is no connection after 5-minute reconnection time, the headphones will automatically power off.
3. To connect to another device, you can enter pairing mode by pressing and holding

LA200W Open-Ear Wireless Headphones

power button, while the headphones are powered off, for 5 seconds until you hear the pairing prompt.

4. If pairing is unsuccessful, simultaneously press and hold volume+ and volume- buttons until you hear a prompt sound. The headphones will automatically power off and restore factory settings.

5. When using dual connection, regardless of which device is currently playing audio, an incoming call will activate ringtone on your headphones.

C. Button Functions

1. Media Control

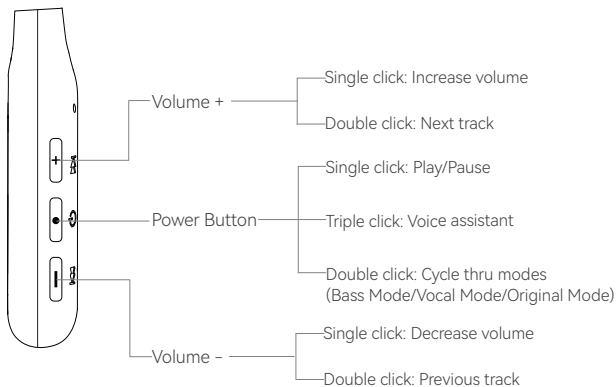

Note: The headphones retain settings from last power-off when turned on again.

LA200W Open-Ear Wireless Headphones

2. Call Control

a) Two-party Call

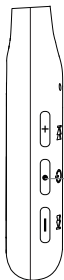

Power Button

Single click: Answer/End call

Long press: Reject call

b) Three-party Call

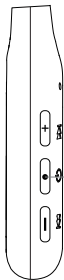

Power Button

Single click: End current and answer incoming
(Incoming call during a two-party call)

Double click: Hold current and answer incoming
(Incoming call during a two-party call)

Single click: End current and answer incoming
(During a three-party call)

Double click: Hold current and switch between
parties
(During a three-party call)

LA200W Open-Ear Wireless Headphones

D. Low Battery Alert

When battery is low while using the headphones, it will prompt about low battery. Please promptly charge the headphones using a Type-C charging cable connected to a power adapter. While charging, the indicator light will illuminate solid orange, and turn solid green once fully charged.

Important: For charging, only use a 5V adapter. Do not use an adapter with a voltage higher than 5V, as it may result in damage.

E. Language Switch

While the headphones are turned on and not connected, simultaneously press and hold power button and volume + button for 2 seconds to switch between Chinese and English prompt tones.

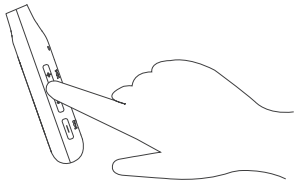

■ Correct Operation

For safe and comfortable operation, please read carefully and abide by the following items:

1. To avoid hearing loss, set the volume of the player to minimum before connecting the headset. After putting the earphone on, increase the volume to a proper level. Noise is measured in decibels (dB). Any outside noise of 85 decibels or more will cause gradual hearing loss.

LA200W Open-Ear Wireless Headphones

2. Please pay attention to your operation habits! Volume and duration are proportional to hearing loss. The higher the volume, the shorter the time you should listen; the more comfortable the volume is, the longer you can listen. Listening at high volume for long will cause damage to your hearing.

This dB level chart compares some common noise sources and their potential danger to your hearing:

Sound Source	Noise Level	Consequence on Hearing
Whisper	30dB	Very quiet
Quiet office	50-60dB	Comfortable hearing level is below 60dB
Vacuum cleaner/ hair dryer	70dB	Somewhat invasive and may interfere with phone calls
Food processor	85-90dB	85dB (continuously 8 hours) will begin to hurt hearing
Garbage cleaning machine/ cement mixer	100dB	Exposure to sound of 90~100dB is suggested to be within 15 minutes if without protection
Electric saw/ electric drill	110dB	Frequent exposure to over 100dB for more than 1 minute can impair hearing
Rock concert (subjective)	110-140dB	Painful hearing starts at about 120dB

■ Maintenance

1. Please keep it in a dry and clean environment. During operation, prevent damage from water ingress, drop or collision.

LA200W Open-Ear Wireless Headphones

2. Operating the headset in high temperature or high humidity for long can lead to device damage or shortened service life.
3. Keep the headset away from strong magnet to avoid demagnetizing and decreased sensitivity and performance.
4. Do not use strong chemical or detergent for cleaning.
5. Do not scratch the product surface with sharp objects.
6. Store in a clean, dry area if not used for a long period. Keep and use away from areas of high temperature and humidity.

■ Cautions

⚠ DANGER

To ensure your personal safety, do not wear or place the headset too close to the pacemaker (less than 10cm).	⊘ Prohibited
Do not insert the cable plug into live power socket.	⊘ Prohibited
For your safety and the safety of other traffic participants, do not use the headset while driving a vehicle, riding a bicycle or walking on the road.	ⓘ Follow
Keep away from fire to avoid explosion.	⊘ Prohibited

⚠ WARNING

Not a toy. Children should not use without adult supervision.	ⓘ Follow
Abide by relative safety rules during operation. Do not use it if prohibited by laws and regulations to avoid accident.	ⓘ Follow

■ Safety Instructions

To avoid electric shock, overheat, fire, radiation, explosion, mechanical risk and injury or property loss due to improper use, please read and observe the following items before use:

1. Please check if the power of the connected equipment matches with that of this product before operation. Adjust the volume to proper level during operation. Do not operate at over-power or high-volume level for extended time to avoid product malfunction.
2. If there is any abnormality during use (e.g., smoke, strange odor), please kill the power switch and unplug from power source, then send the product to the local after-sales service for repair.
3. Keep this product and its accessories in a dry and ventilated area. Do not store in a humid or dusty area for extended time. Keep away from fire, rain, liquid intrusion, bumping, throwing, vibrating, or from blocking any ventilation openings, to prevent malfunction.
4. The product must, when installed on walls or ceilings, be fixed firmly in place at adequate strength to prevent from falling.
5. Please abide by safety rules during operation. Do not use the product in places prohibited by laws or regulations to avoid accident.
6. Do not disassemble or repair the product by yourself to avoid injury. If you have any questions or require any services, please contact our local after-sales service.

■ Label Meanings

 This device is compliant with the limits of the European Council Directive on the approximation of the laws of the member states relating to electromagnetic compatibility according to RL2004/108/EG and European Low Voltage Directive RL2006/95/EG.

 Note: This equipment has been tested and found to comply with the limits for a Class B digital device, pursuant to part 15 of the FCC Rules. These limits are designed to provide reasonable protection against harmful interference in a residential installation. This equipment generates, uses, and can radiate radio frequency energy and, if not installed and used in accordance with the instructions, may cause harmful interference to radio communications. However, there is no guarantee that interference will not occur in a particular installation.

If this equipment does cause harmful interference to radio or television reception, which can be determined by turning the equipment off and on, the user is encouraged to try to correct the interference by one or more of the following measures:

- Reorient or relocate the receiving antenna.
- Increase the separation between the equipment and receiver.
- Connect the equipment to an outlet on a circuit different from that to which the receiver is connected.
- Consult the dealer or an experienced radio/TV technician for help.

Changes or modifications not expressly approved by the complying party may cause the user to lose permission to operate the device.

LA200W Open-Ear Wireless Headphones

This device complies with part 15 of the FCC Rules. Operation is subject to the following two conditions:

- 1) This device may not cause harmful interference, and
- 2) This device must accept any interference received, including interference that may cause undesired operation.

FCC ID: WRALA200W



This symbol indicates that this product should not be disposed of with your household waste, according to the WEEE directive (2012/19/EU) and your national law. This product should be handed over to an authorized collection site for recycling waste electrical and electronic equipment (WEEE). Improper handling of this type of waste could have a possible negative impact on the environment and human health due to potentially hazardous substances that are generally associated with WEEE. At the same time, your cooperation in the correct disposal of this product will contribute to the effective usage of natural resources. For more information about where you can drop off your waste equipment for recycling, please contact your local city office, waste authority, or your household waste disposal service.

■ About This Manual

This manual contains up-to-date technical specifications as of printing. However, specifications contained herein may not conform to your particular product since Takstar is constantly improving its products. Also, specifications, devices or accessories available may vary from region to region. If you have any questions, please contact our local sales outlet. For the latest version/more information, please visit our website:

<https://www.takstar.com/>

Copyright ©2024 TAKSTAR. TAKSTAR, 得胜 and their respective logos are registered trademarks or trademarks of Guangdong Takstar Electronic Co., Ltd. in the PRC, and/or other countries. All other trademarks are the property of their respective owners.

注意事项:

1. 本单为保修凭证, 请用户妥善保管, 如有遗失, 恕不保修或退换。
2. 保修期限制: 购买之日起十二个月内。
3. 除了不可抗力事件损坏外, 由本公司负责, 免费维修。
4. 如属保管不善或使用不当造成的损坏, 维修点将酌情收费。
5. 擅自拆卸维修者, 不予保修。
6. 以上保修条款仅限于中国市场适用 (不含港澳台地区)。

产品服务保证书

姓名: _____ 电话: _____ 地址: _____
商品: _____ 型号: _____ 购买日期: _____ 年 ____ 月 ____ 日

维修记录栏 (由维修员填写)	维修员签名	日期



扫一扫，了解更多产品
Scan for more
product information

广东省电声工程技术研究开发中心 广东得胜电子有限公司制造

地址: 广东省惠州市博罗县龙溪街道富康一路2号
服务热线: 400 6828 333 传真: 0752 6383950
邮箱: xs@takstar.com
网址: www.takstar.com

Designed & Manufactured by:

Guangdong Takstar Electronic Co., Ltd.
Address: No.2 Fu Kang Yi Rd., Longxi Boluo
Huizhou, Guangdong 516121 China
Tel: 86 752 6383644 Fax: 86 752 6383952
Email: sales@takstar.com
Website: www.takstar.com

