

# TAKSTAR® 得胜



**SM-10** | 专业录音麦克风  
Professional Recording Microphone

使用手册 | User Manual

# SM-10 专业录音麦克风

---

## ■ 前言

尊敬的用户：

感谢您选购得胜SM-10专业录音麦克风，为了您能够更好的了解使用本产品，建议您在使用前仔细阅读本说明书。

若存在有疑问或者您有宝贵的建议，可通过拨打得胜官方服务热线400 6828 333或微信扫描二维码关注得胜官方公众号与我们联系。



## ■ 产品特性

- $\Phi$ 34mm镀金大振膜音头，宽广的频率响应确保声音真实还原；
- 出色的声压电平处理能力，适合拾取各种不同类型的音源；
- 高灵敏度设计，轻松录制丰富的声音细节、声音呈现更出众；
- 设有低频衰减开关，有效降低环境噪音，录制声音更干净；
- 设有灵敏度衰减开关，可承受高声压级拾音，防止过载失真；
- 配置金属防震架，出色的隔震性能，防止震动声的传导；
- 专用防风网有效过滤喷麦声，精致的造型避免遮挡用户的脸部。

## ■ 适用范围

大合唱、专业录音、影视配音等场合

## ■ 标准配置

- 麦克风 1支
- 防震架 1个
- 橡皮筋 2条
- 防风棉 1个
- 防风网 1个
- 说明书 1份

## ■ 技术参数

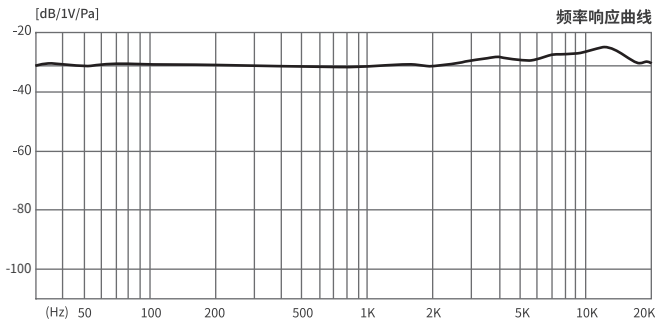

- 音头：Φ34mm镀金大振膜音头
- 指向性：单指向
- 频率响应：20Hz-20kHz
- 0dB灵敏度：-30dB±3dBV(0dB=1V/Pa at 1KHz)
- -10dB灵敏度：-40dB±3dBV(0dB=1V/Pa at 1KHz)
- 低频衰减：100Hz (6dB/oct)
- 等效噪声级：≤20dBA (IEC 581-5)
- 峰值声压级：140dB (THD≤1% at 1KHz)
- 输出阻抗：110Ω±30%(at 1kHz)
- 工作电压：48V幻象电源
- 单体尺寸：Φ50mm\*194mm
- 单体重量：约430g

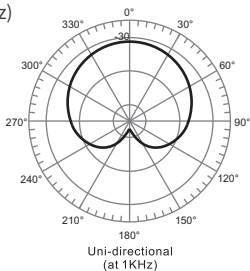

注：以上数据由得胜实验室测试得到，并拥有最终解释权！

### ■ 功能示意

#### 1. 低频衰减功能:

(1) 开关拨到“—”位置时，能够拾取真实的声源，一般在环境比较安静的情况下（如消声室）使用；

(2) 开关拨到“/”时可滤除150Hz以下的低频环境噪声（如交通、空调系统、舞台地板震动声等），有效降低喷麦声，使音质更加清晰

#### 2. 灵敏度衰减功能:

(1) 当开关拨到“0dB”位置时，为无衰减状态；

(2) 当开关拨到“-10dB”位置时，灵敏度衰减-10dB，能够承受更高的声压，一般在高声压级大动态拾音场合使用（如交响乐队的低频鼓、小号等乐器拾音）。

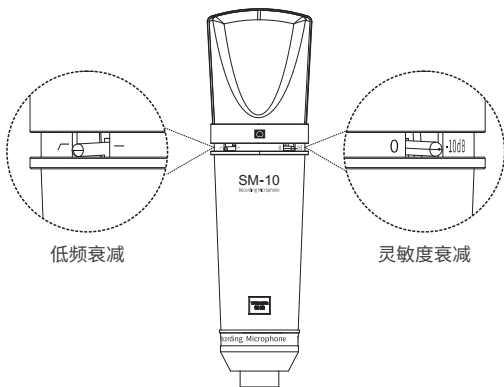

### ■ 使用说明

1. 将防震架安装到麦克风支架或吊杆上，并旋紧防震架上的固定螺母。建议防震架安装固定好后正面朝上，底部螺母朝下，以防麦克风夹不紧时从防震架中脱落造成损坏；

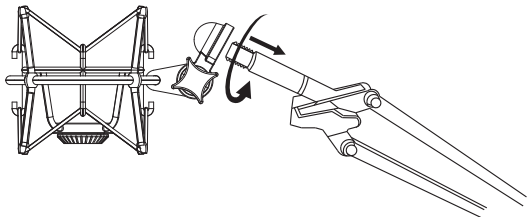

2. 麦克风印有“SM-10”产品型号和一个“○”心型指向性标记的一面为正面，将麦克风的正面对准声源，安置到防震架中，旋紧防震架底部的螺母到完全夹紧麦克风；

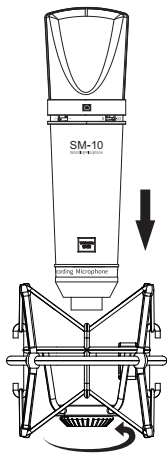

## SM-10 专业录音麦克风

3. 通过防风网上的卡扣将防风网安装到防震架上；

如图所示：

提示：也可以去掉防风网，换成用防风棉，两者只选用一款即可。防风网比较美观，对于声音的保真度保持比较好，但防口水作用没有防风棉好。防风棉虽然防口水作用较好，但因为遮挡了麦克风头部，影响了麦克风整体美感，而且通透性没有防风网好，对麦克风音质还有轻微的影响。可根据个人喜好选择是否安装防风棉。

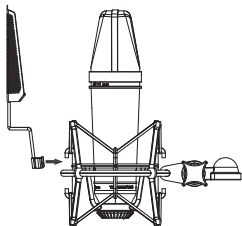

4. 将麦克风的接口通过公母卡侬线连接到具有48V幻象电源的音频设备（如声卡、调音台、功放等），如果设备本身没有幻象电源，则需要另购一个48V幻象电源进行连接；

注意：本产品需求的48V幻象电源规格： $DC\ 48V \pm 4V / 2.8mA \pm 20\%$

① 音频设备带48V供电的连接方法：

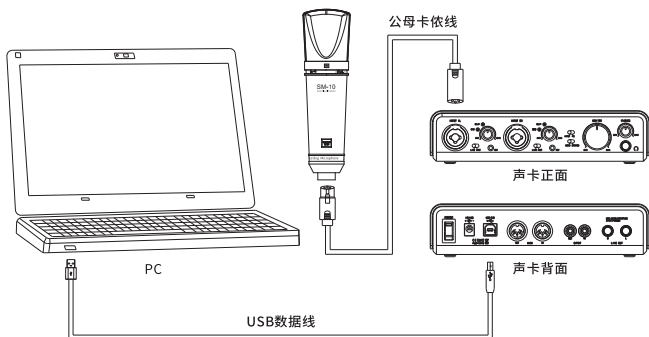

## SM-10 专业录音麦克风

### ② 音频设备不带48V供电的连接方法：

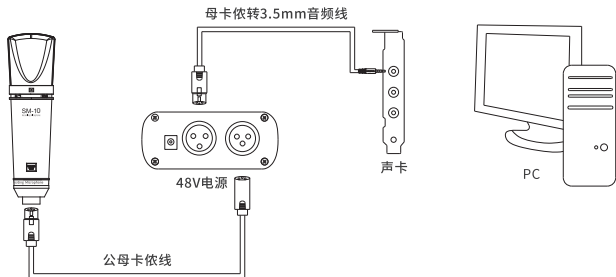

5. 将连接线固定在麦克风支架或吊杆上，在麦克风位置预留一圈连接线，这种做法可实现有效的隔震效果；
6. 使用时，应先将设备音量调小，再打开幻象电源开关，并将音量从小到大慢慢调节至合适，以免声压过大对扬声器产生冲击；尽可能的拉开麦克风与扬声器的距离，避免麦克风和扬声器相对，从而有效控制回馈啸叫；
7. 麦克风输出接口是三针XLRM接口，其极性如图所示：

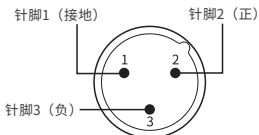

### ■ 安全警示

为避免电击、高温、着火、辐射、爆炸、机械危险以及使用不当等可能造成的人身伤害或财产损失，使用本产品前，请仔细阅读并遵守以下事项：

1. 使用产品时请确认所连接设备与本产品功率是否匹配以及合理调整设备音量大小，不要在超过产品功率及大音量下长时间使用，以免造成产品异常；
2. 使用中若发现有异常（如冒烟、异味等），请立即关闭电源开关并拔掉电源插头，然后将产品送售后服务网点检修；
3. 本产品及配件都应放置在室内干燥通风处，勿长期存放在潮湿、灰尘多的环境，使用中避免靠近火源，雨淋、进水、过度碰撞、抛掷、振动本机及覆盖通风孔，避免损坏其功能；
4. 若产品需要固定于墙壁或天花板上时，请确保固定到位，防止因固定强度不足导致产品发生跌落危险；
5. 使用该产品时需遵守相关安全规定，法律法规明确禁止使用场合请勿使用产品，以免导致意外事故；
6. 请不要自行拆机改装或维修，以防止出现人身伤害，如有问题或服务需求请联系当地售后服务网点跟进处理；



### ■ 关于图标含义解释



根据RL2004/108/EG和European Low Voltage Directive（欧洲低电压指令）RL2006/95/EG的测试结果表明，本产品符合欧共体关于电磁兼容性的成员国法律整合的指令中所规定的限值。



未经合规方明确批准的变更或修改可能会使用户失去操作设备的权限。此设备符合FCC规则第15条部分的要求。操作须符合以下两个条件：（1）此设备可能不会造成有害干扰；（2）此设备必须接受接收到的任何干扰，包括可能导致意外操作的干扰。



此符号表示，根据WEEE指令(2012/19/EU)和国家法律，由于这种类型的废弃物会有潜在的有害物质，可能对环境 and 人类健康产生负面影响，所以本产品不应与您的家庭垃圾一起处置，应将本产品交由授权的电气和电子设备（WEEE）回收站回收。同时，您在正确处理本产品的同时将有助于自然资源的有效利用。如需了解更多有关您可以在何处放置废物回收设备的信息，请联系您当地的城市办事处、废物管理局或家庭废物处理服务部门。

### ■ 关于本说明书

本说明书中内容符合截止印刷之日的技术规格。由于得胜公司会不断改进产品，本说明书可能不符合您的特定产品的技术规格。要获取最新版说明书，请访问得胜官网，然后下载说明书文件。技术规格、设备或另售的附件在各个地区可能有所不同，如有问题请与当地得胜销售网点确认。如需更多支持和深层产品信息，请浏览得胜官方网站：<https://www.takstar.com>

## ■ 环保说明

产品中有毒有害物质或元素的名称及含量标识表

部件名称	有毒有害物质或元素					
	铅 (Pb)	汞 (Hg)	镉 (Cd)	六价铬 (Cr(VI))	多溴联苯 (PBB)	多溴二苯醚 (PBDE)
塑料部件	○	○	○	○	○	○
金属部件	×	○	○	○	○	○
电路板组件	×	○	○	○	○	○
线缆	×	○	○	○	○	○

本表格依据SJ/T 11364的规定编制。

○: 表示该有害物质在该部件所有均质材料中的含量均在 GB/T 26572规定的限量要求以下。

×: 表示该有害物质至少在该部件的某一均质材料中的含量超出 GB/T 26572规定的限量要求。

此标志为产品的环保使用期限标志，  
且此环保使用期限只适用于产品正常工作的温度和湿度等条件。



### ■ Preface

Dear Customer,

Thank you for purchasing Takstar SM-10 Professional Recording Microphone. In order to better understand and use the product, please read this manual carefully. If you have any questions or suggestions, please contact our local dealer.

### ■ Features

- $\varnothing$ 34mm gold-plated large-diaphragm capsule with wide frequency response.
- Excellent SPL processing capability for recording various audio sources.
- Captures rich acoustic details at high sensitivity for better performance.
- Low cut filter to effectively rid of ambient noise and ensure clean recording.
- Attenuation pad caters for high SPL recording and prevents overload distortion.
- First-class metal shock mount for shock absorption.
- Dedicated exquisite pop screen filters out pop noise effectively without obstructing your face.

### ■ Applications

Chorus, professional recording, voiceover.

### ■ Package Contents

- Microphone 1 pc
- Shock Mount 1 pc
- Elastic Band 2 pcs
- Windscreen 1 pc
- Pop Screen 1 pc
- User Manual 1 pc

## ■ Specifications

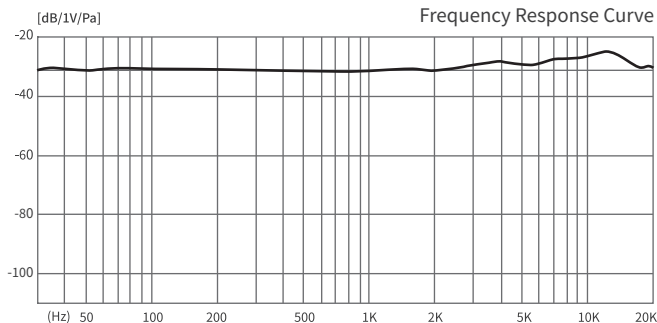

- Capsule:  $\varnothing 34\text{mm}$ , gold-plated large diaphragm
- Polar Pattern: unidirectional
- Frequency Response: 20Hz-20KHz
- 0dB Sensitivity:  $-30\text{dB} \pm 3\text{dBV}$  ( $0\text{dB}=1\text{V/Pa}$  at 1KHz)
- -10dB Sensitivity:  $-40\text{dB} \pm 3\text{dBV}$  ( $0\text{dB}=1\text{V/Pa}$  at 1KHz)
- Low Cut: 100Hz (6dB/oct)
- Equivalent Noise Level:  $\leq 20\text{dBA}$  (IEC 581-5)
- Peak SPL: 140dB (THD $\leq 1\%$  at 1KHz)
- Output Impedance:  $110\Omega \pm 30\%$ (at 1KHz)
- Power Supply: 48V phantom power
- Mic Dimensions:  $\varnothing 50\text{mm} \times 194\text{mm}$
- Mic Weight: approx. 430g

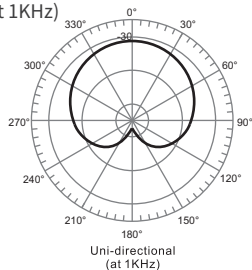

Note: The above data are measured by Takstar laboratory, and Takstar has the final interpretation right!

### ■ Function Descriptions

#### 1. Low Cut:

- 1) Switch to "—": records sound as it is, generally used in a quiet environment (e.g., anechoic room).
- 2) Switch to "∩": filters out low-frequency environmental noise below 150Hz (e.g., traffic, air-conditioner, stage floor vibration), and effectively reduces plosives for clearer sound.

#### 2. Attenuation Pad:

- 1) Switch to "0dB": no attenuation.
- 2) Switch to "-10dB": attenuates sensitivity by 10dB for recording higher sound pressure, usually used in areas with high SPL (e.g., instruments like bass drum, trumpet in a symphony orchestra).

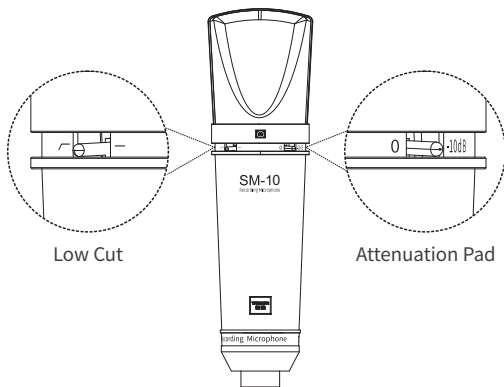

### ■ Operation Instructions

1. Assemble the shock mount onto the mic stand or boom arm, and tighten the fixing nut on the shock mount. It is recommended to keep the shock mount upwards and bottom screw downwards, to prevent accidental mic drop and damage in case of loose mic clamping.

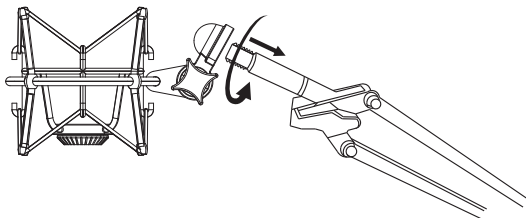

2. The front side of the mic is silkscreened with the model number "SM-10" and a "⊙" cardioid symbol. Face the front side towards the sound source. Install the mic onto the shock mount by tightening the bottom screw until fully secured.

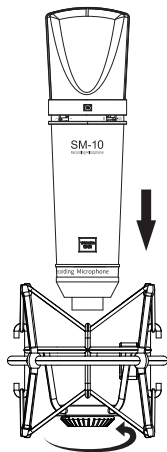

## SM-10 Professional Recording Microphone

### 3. Fasten the pop screen onto the shock mount via the bottom clip.

Tips: You can also replace the pop screen with the foam windscrew. Use either one at your preference. Compared to the foam windscrew, the pop screen provides better aesthetics, maintains slightly higher audio transparency/fidelity, and does not block view of the mic capsule, but offers lesser protection from speech droplets.

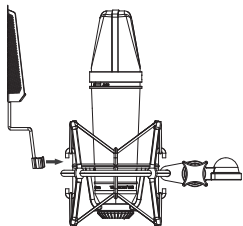

4. Using the XLR male-to-female cable, connect the mic to an audio device (e.g., audio interface, mixing console) with built-in 48V phantom power supply, or use an external 48V power supply (not included) if none.

Note: The phantom power supply requirement for this product is  $DC\ 48V \pm 4V / 2.8mA \pm 20\%$ .

① Connection to audio device with built-in 48V phantom power:

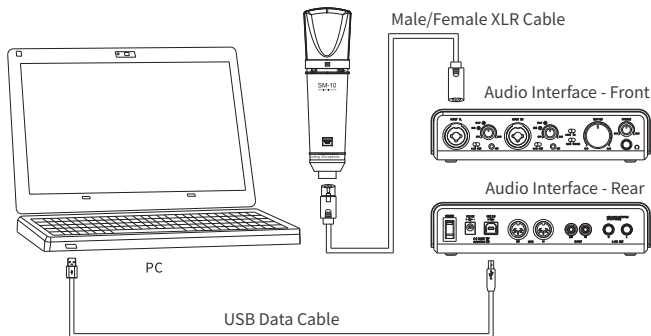

## SM-10 Professional Recording Microphone

② Connection to audio device without built-in 48V phantom power:

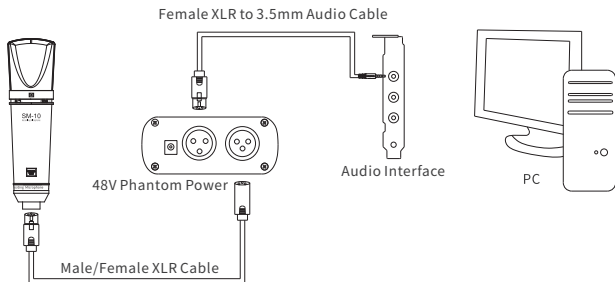

5. Fix the connection cable onto the mic stand or boom arm, and leave a section/loop of cable at the mic. This helps to effectively isolate the vibration.

6. Please turn the volume to the minimum on the audio device before switching on the phantom power. Then gradually increase the volume to an appropriate level. This helps to prevent speaker damage from high sound pressure. Keep a proper distance between the mic and the speakers to avoid feedback howling.

7. The mic output uses a three-pin XLR male connector, as shown below:

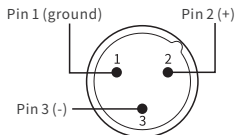



### ■ Safety Instructions

To avoid electric shock, overheat, fire, radiation, explosion, mechanical risk and injury or property loss due to improper use, please read and observe the following items before use:

1. Please check if the power of the connected equipment matches with that of this product before operation. Adjust the volume to proper level during operation. Do not operate at over-power or high-volume level for extended time to avoid product malfunction or hearing impairment.
2. If there is any abnormality during use (e.g., smoke, strange odor), please kill the power switch and unplug from power source, then send the product to the after-sales service outlet for repair.
3. Keep this product and its accessories in a dry and ventilated area. Do not store in a humid or dusty area for extended time. Keep away from fire, rain, liquid intrusion, bumping, throwing, vibrating, or from blocking any ventilation openings, to prevent malfunction.
4. The product must, when installed on walls or ceilings, be fixed firmly in place at adequate strength to prevent from falling.
5. Please abide by safety rules during operation. Do not use the product in places prohibited by laws or regulations to avoid accident.
6. Do not disassemble or repair the product by yourself to avoid injury. If you have any questions or require any services, please contact our local after-sales service outlet.

### ■ Label Meanings

**CE** This device is compliant with the limits of the European Council Directive on the approximation of the laws of the member states relating to electromagnetic compatibility according to RL2004/108/EG and European Low Voltage Directive RL2006/95/EG.

**FCC** Note: This equipment has been tested and found to comply with the limits for a Class B digital device, pursuant to part 15 of the FCC Rules. These limits are designed to provide reasonable protection against harmful interference in a residential installation. This equipment generates, uses, and can radiate radio frequency energy and, if not installed and used in accordance with the instructions, may cause harmful interference to radio communications. However, there is no guarantee that interference will not occur in a particular installation. If this equipment does cause harmful interference to radio or television reception, which can be determined by turning the equipment off and on, the user is encouraged to try to correct the interference by one or more of the following measures:

- Reorient or relocate the receiving antenna.
- Increase the separation between the equipment and receiver.
- Connect the equipment to an outlet on a circuit different from that to which the receiver is connected.
- Consult the dealer or an experienced radio/TV technician for help.

Changes or modifications not expressly approved by the complying party may cause the user to lose permission to operate the device.

This device complies with part 15 of the FCC Rules. Operation is subject to the following two conditions:

## SM-10 Professional Recording Microphone

---

- 1) This device may not cause harmful interference, and
- 2) This device must accept any interference received, including interference that may cause undesired operation.



This symbol indicates that this product should not be disposed of with your household waste, according to the WEEE directive (2012/19/EU) and your national law. This product should be handed over to an authorized collection site for recycling waste electrical and electronic equipment (WEEE). Improper handling of this type of waste could have a possible negative impact on the environment and human health due to potentially hazardous substances that are generally associated with WEEE. At the same time, your cooperation in the correct disposal of this product will contribute to the effective usage of natural resources. For more information about where you can drop off your waste equipment for recycling, please contact your local city office, waste authority, or your household waste disposal service.

### ■ About This Manual

This manual contains up-to-date technical specifications as of printing. However, specifications contained herein may not conform to your particular product since Takstar is constantly improving its products. Also, specifications, devices or accessories available may vary from region to region. If you have any questions, please contact our local sales outlet. For the latest version/more information, please visit our website: <https://www.takstar.com/>



## 产品服务保证书

姓名：\_\_\_\_\_ 电话：\_\_\_\_\_ 地址：\_\_\_\_\_

商品：\_\_\_\_\_ 型号：\_\_\_\_\_ 购买日期：\_\_\_\_\_ 年 \_\_\_ 月 \_\_\_ 日

维修记录栏(由维修员填写)	维修员签名	日期

### 注意事项：

1. 本单为保修凭证，请用户妥善保管，如有遗失，恕不保修或退换。
2. 保修期限制：购买之日起十二个月内。
3. 除了不可抗力事件损坏外，由本公司负责，免费维修。
4. 如属保管不善或使用不当造成的损坏，维修点将酌情收费。
5. 擅自拆卸维修者，不予保修。
6. 以上保修条款仅限于中国市场适用（不包含港澳台地区）。



扫一扫，了解更多产品  
Scan for more  
product information

## **广东省电声工程技术研究开发中心 广东得胜电子有限公司制造**

地址：广东省惠州市博罗县龙溪街道富康一路2号

服务热线：400 6828 333 传真：0752 6383950

邮箱：xs@takstar.com

网址：www.takstar.com

Guangdong Takstar Electronic Co., Ltd.

Address: No. 2 Fu Kang Yi Rd., Longxi Boluo

Huizhou, Guangdong 516121 China

Tel: 86 752 6383644 Fax: 86 752 6383952

Email: sales@takstar.com

Website: www.takstar.com