

TAKSTAR® 得胜

TKA系列 专业功率放大器

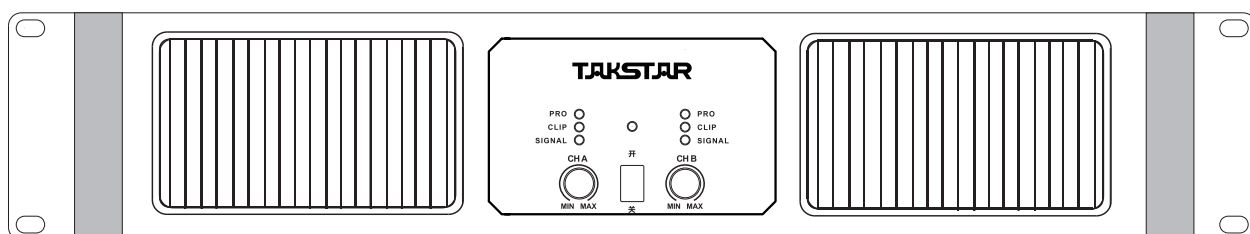

感谢您购买我们的产品！

为了保护您的安全，请您使用功放前完全阅读手册，并保留此手册以备将来参考。

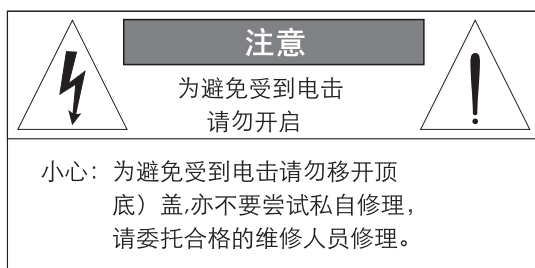

重要的安全事项(针对火灾,电击或伤害人体的指示)

注意： 使用电器产品时，有以下基本的预防措施， 以下包括：

- 1、使用该产品前请详细阅读全部的安全事项；
- 2、请在海拔2000米以下和非热带地区使用。



- 3、本产品应当接地，如果出现故障时，电流经最小的接地电阻流入大地，以减小电击；本产品的电源线和电源插头都配备安全接地，电源插头应当牢固插入适当的电源座，此电源座应当完全按当地的条例来安装和接地。

警告： 接地装置连接不当会导致电击；如果你对产品是否正确接地存在任何疑问，请委托合格电工或维修人员检查；请不要尝试私自更改产品的电源插头，如果不适合电源插座，可委托合格电工安装适当的电源插座。

- 4、为了减小伤害的风险，当产品在小孩附近使用时，要严密监管。
- 5、请勿在湿度很高的地方使用机器，例如靠近浴缸、洗脸盆、厨房水槽、温度很大的地下室或者靠近游泳池和湖泊。
- 6、该产品有可能产生导致永久性听觉丧失的音量，请勿长时间在很大或令人很不舒服的音量下动作。如果你察觉到有任何听力丧失或者耳朵发响，应当咨询听觉病矫正专家。
- 7、该产品应当安装于通风良好的地方。
- 8、该产品必须远离热源，例如电暖炉、电热毯或者其它产生热量的产品。
- 9、该产品的电源类型必须符合操作提示或者产品上标明的类型。
- 10、该产品要配备一条两端的电源线（一端的插片长过另一端）。这是安全装置。如果你无法把电源插头插入电源插座，请联系电工来更换旧插座。请勿破坏电源插头的安全装置。
- 11、长时间不使用时，请把电源线从电源插座中拔出，从电源座拔出电源线时，请勿拉扯电源线，应当抓住电源插头将其拔出。
- 12、细心护理，请勿让杂物或液体从其缝隙掉进机内。
- 13、当有下列情况时，应委托合格维修人员修理。
 - A、电源线或电源插头已被损坏；
 - B、杂物或液体已掉进机内；
 - C、产品已被雨淋；
 - D、产品已不能正常操作或在演出中出现明显变化；
 - E、产品已跌坏或外观损坏。
- 14、当出现没在用户维修指南中描述的情况时，请勿尝试私自修理，应当委托合格的维修人员修理。
- 15、**警告：** 勿让重物积压或踩踏电源线，切忌拉、拔或强力扭曲电源线。
勿滥用电源线，不合格的电源线可能导致火灾或对人造成伤害。

请保存这些安全事项



目录



目录	1
安装和操作说明	2
功能和控制说明	3
技术指标	7

安装及操作说明

主电源的连接

- ① 将功放连接到电源插座之前，请确认电源电压符合功放后板下所标注的电压要求，（AC220V ± 10%）。将电源接上电源插座之前，请确认电源线没损坏。在开机前连好电源线；在关机后拔掉电源线。

开关机

- ② 在音响系统里面，功放是最迟打开及最早关闭。在连接其它设备时，要关掉功放。先打开调音台，后打开功放。按此顺序，避免对音箱造成损害。



注意

- ③ 为了保护好电源线和连接线，不允许用力挤压电源线和连接线。

不得受雨淋或水溅

④

勿将本机放置在湿度很高的地方，不能受雨淋或水溅。有水的物体不能摆在本机的上方。避免在本机附近喷洒杀虫剂或使用化学品如酒精、涂料、稀释剂、松香水等溶剂抹机箱。

风槽

⑤

为了保证功放的正常工作，切勿阻塞风槽（进风口和出风口）如果功放在很恶劣的环境下使用，请确认在功放周围有足够的空间。避免将功放安置于狭小，不利于空气流通的地方。

注意高压

⑥

注意输出端高压、极性，请勿短路。在本机工作时，请勿触摸本机的输出端子，否则有可能对人造成伤害。

TKA系列功放前面板示意图

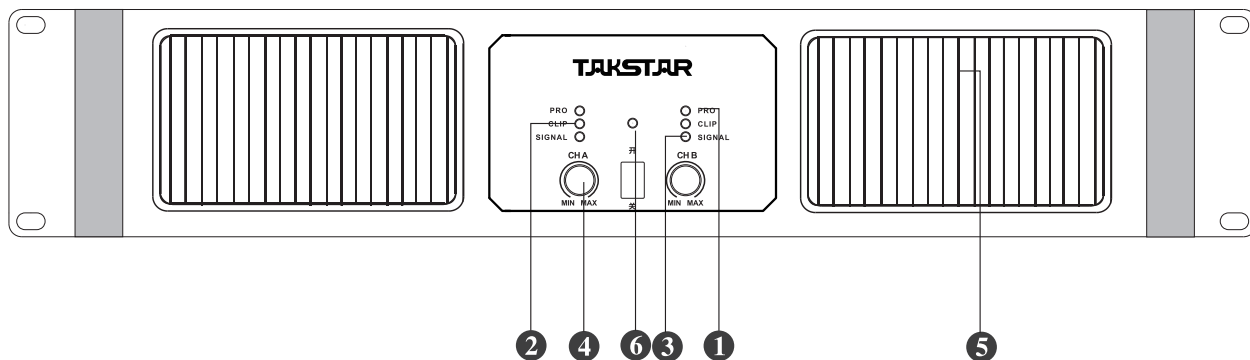

TKA系列功放后板示意图

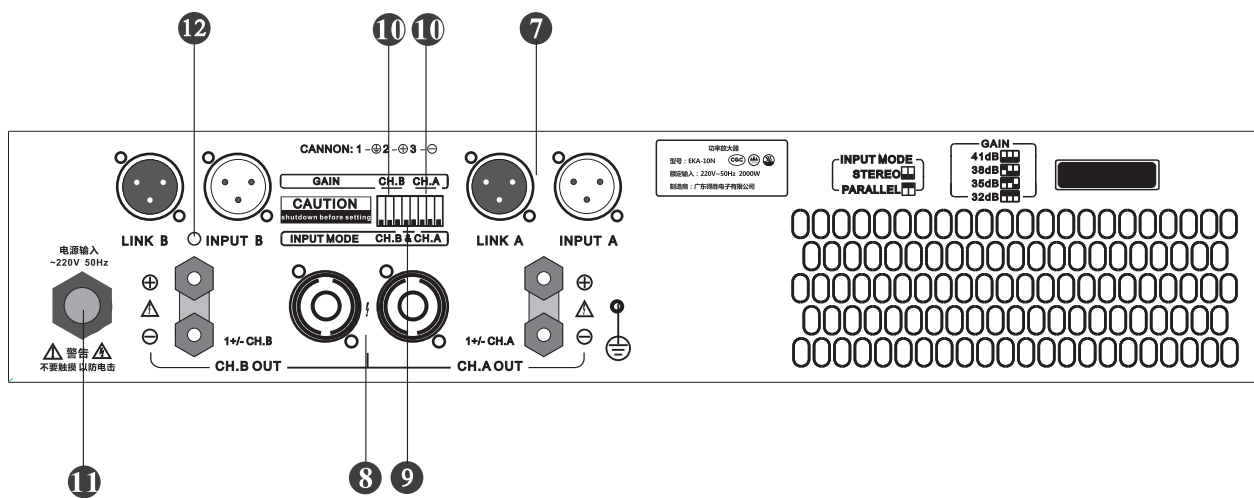

1 保护指示灯

保护指示灯点亮。

如果保护指示灯点亮，这表明功放的保护电路由于负载有问题或者其它方面故障而动作了，保护电路通过继电器切断功放的输出。

产品的保护电路说明如下：

- 1) 电源开机交流软启动：抑制启动电流，不影响其它设备工作和保护机内电路免受冲击；
- 2) 开机延时接载：保护音箱免受冲击，无声开机；
- 3) 直流输出断载保护：中点漂移和有直流输出时，防止音箱受冲击而损坏；
- 4) 过流自动跟踪输出限流软保护：当负载阻抗过低和输入信号过激时，对功放本身和音箱保护；
- 5) 削波压缩保护：当输入信号过大时，使功放削峰失真输出，容易损坏喇叭，本电路能自动检测压缩信号保护音箱；
- 6) 负载短路保护：当输出短路时，短路电流过大，保护自动切断输出，保护功放，当短路解除后自动恢复；
- 7) 过热保护：当在高温环境和低负载工作时，机内温升较快，当功放组件温度超过90℃时，过热保护自动起控，切断负载，当温度低于75℃时自动恢复工作；
- 8) 关机保护：关机时先切断负载，实现无声关机保护音箱免受冲击。



有些保护电路需要把功放关掉然后重开，才能恢复正常的操作状态。

2 压限指示灯

功放状态指示灯。压限指示灯点亮表明功放内压缩保护电路开始动作，功放的输入信号过大，应该要减小。可见，压限指示灯也反映了经音量电位器控制后的信号幅度大小。

3 信号指示灯

当功放有输出时，信号指示灯会闪烁，指示功放开始输出。

4 音量电位器

控制信号输入电平：音量电位器可以由“MIN”的位置旋转到“MAX”的位置；

音量电位器置于“MIN”时，没有信号输入功放；

音量电位器置于“MAX”时，信号全部输入功放；

音量电位器就是一个输入功放信号的衰减器。

5 通风孔

功放散热系统空气进出气孔。

散热系统：由前面板开进风孔，后板开出风孔，创造了由前向后的空气流通条件，增强通风量，提高了散热效率。

6 电源开关

打开及关闭功放电源，打开时电源指示灯点亮。

7 信号输入端口

每个通道各有1个母卡侬输入座和1个并联输出的公卡侬输出座。

8 功率输出端口

CHA 输出座:1+为 CHA “⊕”，1-为 CHA “⊖”，2+为 CHB “⊕”，2-为 CHB “⊖”；
CHB 输出座:1+为 CHB “⊕”，1-为 CHB “⊖”；

接法1:

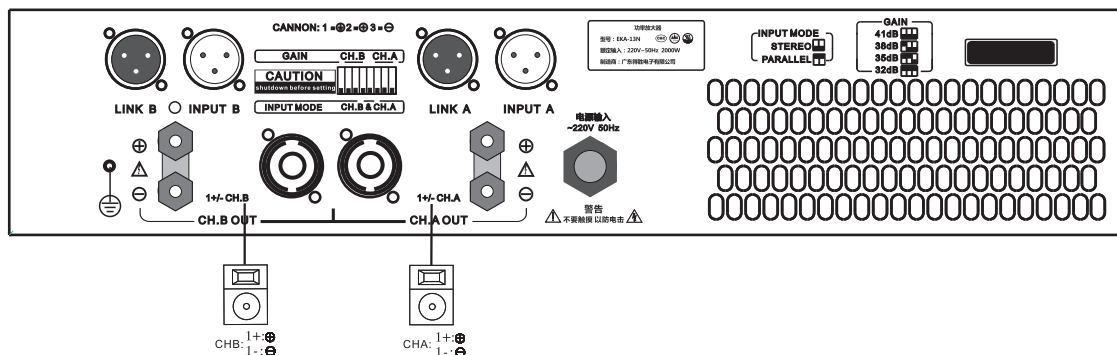

接法2:

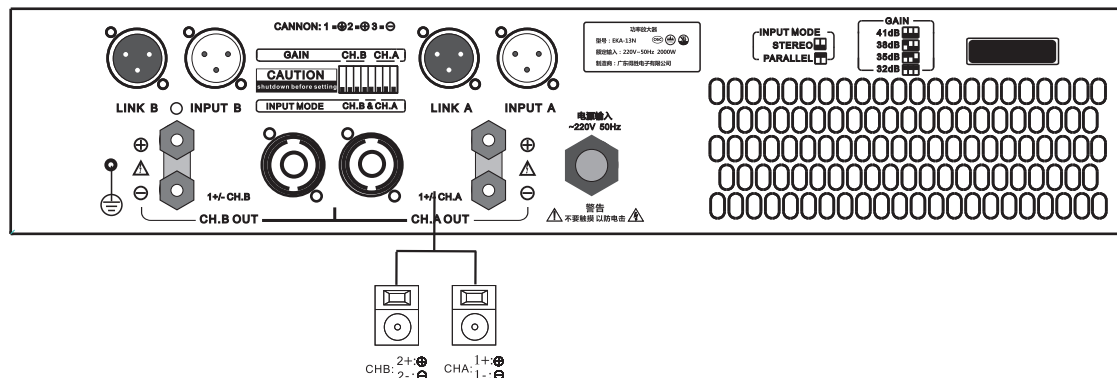

9 立体声/并联模式选择开关

设定功放两种状态：立体声和并联。在音响系统中利用此开关，可以方便搭配其它设备，例如：调音台、电子分频器、音箱、功放。



这个开关仅能在功放关闭时才能使用，否则有可能对喇叭单元造成冲击。

A) 立体声

设定在立体声状态下，2个独立的信号分别由2个通道分别放大。

开关处于关闭状态时，为立体声状态。示意图如下：

B) 并联模式

设定在并联状态下，输入1个信号，并联通道同时有信号输出。

A & B开关开启（向上拨）时，IN.A和IN.B 并联。示意图如下：

10 增益调节

可根据要求设置功放每通道的增益（41dB/38dB/35dB/32dB）。



11 电源接口

12 静噪门开关

出厂设置默认为-80dB，按一下为-75dB，再按一下变回-80dB，以此循环。

长按5秒关闭静噪门功能，再长按5秒打开静噪门功能。

功率放大器技术参数

EIA测试标准 输入电压 AC220V,1KHz , 最大谐波失真:0.3%, 单通道测试。	型号	8Ω	4Ω	重量
	TKA-46	400W	600W	16.5kg
	TKA-70	700W	1000W	17.5kg

技术指标		
	TKA-46	TKA-70
输入增益	41dB/38dB/35dB/32dB	
输入阻抗	30KΩ (平衡/立体声)	15KΩ (非平衡/并联)
频率响应	20-20000Hz(±0.3dB)	
转换速率	≥12V/us	
阻尼系数	≥300	
通道隔离	>61dB@1KHz	>62dB@1KHz
信噪比	>110dB	>115dB
总谐波失真+噪音	<0.01% 8Ω,1W@1KHz	
互调失真	<0.05%	
保护功能	放大器 扬声器	电源开/关保护 晶体管热保护 短路保护 过流保护 限幅器
控制方式	前面板	AC电源开关 每通道输入电平控制旋钮
	后板	立体声/并联 选择 输入增益选择
指示器	前面板	电源：1×绿色LED 保护：2×红色LED 削峰：2×黄色LED 信号：2×绿色LED
连接	输入	每通道两个Neutrik XLR接口
	输出	每通道1个Neutrik Speakon 输出座+1个接线柱
电源供应	根据设备上的标签提示匹配使用	
尺寸(宽×高×深)	483×88×447mm(含把手)	

产品服务保证书

姓名：_____ 电话：_____ 地址：_____

商品：_____ 型号：_____ 购买日期：_____年__月__日

维修记录栏 (由维修员填写)	维修员签名	日期

注意事项：

1. 本单为保修凭证，请用户妥善保管，如有遗失，恕不保修或退换。
2. 保修期限制：购买之日起十二个月内。
3. 除了不可抗力事件损坏外，由本公司负责，免费维修。
4. 如属保管不善或使用不当造成的损坏，维修点将酌情收费。
5. 擅自拆卸维修者，不予保修。
6. 以上保修条款仅限于中国内地适用（不包括港澳台地区）。



ELECTRICAL SPECIFICATIONS		POWER SPECIFICATIONS	
Amplifier Gain	41dB/38dB/35dB/32dB	TKA-46	TKA-70
Amplifier Impedance	30K Ω (balanced, stereo) 15K Ω (unbalanced, parallel)		
Frequency response	20-20000Hz(\pm 0.3dB)		
Slew rate	\geq 12V/ μ s		
Damping factor	\geq 300		
Crosstalk	<61dB@1KHz		>62dB@1KHz
S/N	>110dB		>115dB
Total harmonic distortion (THD+N)	<0.01% 8 Ω ,1W@1KHz		
Inter-modulation distortion (IMD)	<0.05%		
GENERAL SPECIFICATIONS			
PROTECTIONS	Amplifier Speakers	Transistor thermal protection Short circuit protection Sensor for current on outputs Limiter	
CONTROLS	Front panel	ON/OFF switch Signal level control for each channel	
	Back panel	STEREO/PARALLEL selector Input gain adjust	
INDICATORS	Power: 1 blue ; Protect: 2 red ; Clip: 2 yellow ; Signal: 2 blue.		
CONNECTORS	Input	Two Neutrik XLR connectors each channel	
	Output	1 Neutrik speakon + 1 Binding-Post connector each channel	
POWER SUPPLY	See label on the apparatus		
DIMENSIONS(W×H×D)	483×88×447mm		

AMP SERIES TECHNICAL SPECIFICATIONS				Power specifications	
EIA AC220V output power 1KHz Max THD 0.3% Test mono	MODE	8 Ω	4 Ω	Weight	16.5kg
	TKA-46	400W	600W		17.5kg
	TKA-70	700W	1000W		

9 STEREO/ PARALLEL selector

Selector for the amplifiers 2 operating settings: allows to decide how use the amplifier in the audio setup, Connect with other units (crossovers, other amplifiers, loudspeaker enclosures).

This control should only be used when the amplifier off, otherwise the loudspeaker's Components could be damaged.



A) STEREO

With the STEREO setting, 2 separate signals are treated separately by each channel of the amplifier.

B) PARALLEL MODE

With the parallel setting, when inputting one signal, the parallel channel can output signal at the same time.

When switch 1 & 2 open, CH.A and CH.B are parallel.

10 GAIN adjust

According to different file, it can set different gain for each channel (32dB/35dB/38dB/41dB).

11 POWER INTERFACE

12 NOISE GATE

The factory default is - 80dB. Click to change to -75dB, and click again to change back to -80dB. In this cycle. Press and hold for 5 seconds to close the squelch door function, and then press and hold for another 5 seconds to open the squelch door function

5 AIR VENTS

Amplifier cooling system air in/out vents:
 The fan of the cooling system create a flow of air with front to back direction: this means that the Air is taken from the front panel to the back cover, and having cooled the heat sinks and transformer. through the opening on the back side. Care must always be taken to avoid blocking these openings and to never place the amplifier in a position which does not allow sufficient air circulation.

6 POWER ON

ON/OFF switch with indication LED. (Active LED)

7 INPUTS

Each channel has a XLR input, and a XLR input for parallel output.

8 OUTPUTS

STEREO outputs : output of CHA : the "1+" is the "⊕" of CHA, the "1-" is the "⊖" of CHA, the "2+" is the "⊕" of CHB, the "2-" is the "⊖" of CHB.
 output of CHB : the "1+" is the "⊕" of CHB, the "1-" is the "⊖" of CHB.

Wiring method 1 :

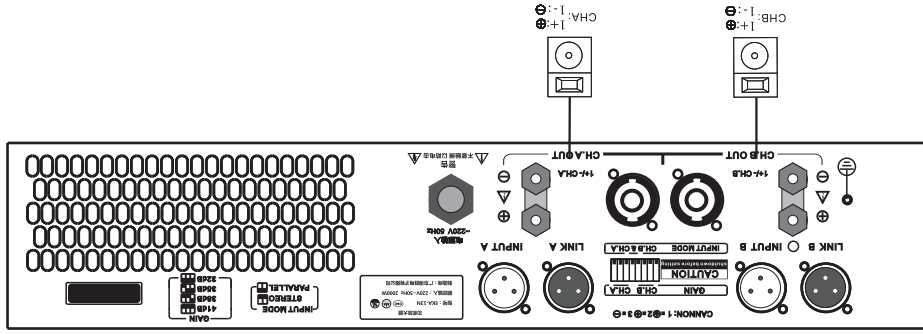

Wiring method 2 :

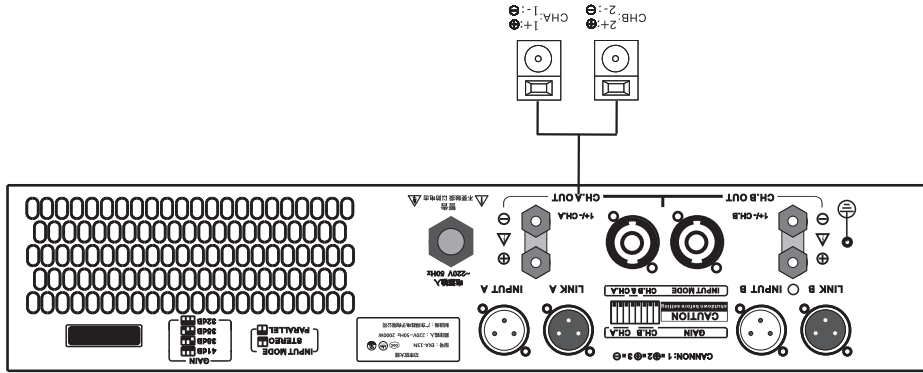

1 PROTECTLEDS



Protection pilot lights
 If these LEDS light up, this indicates that one of the various protections safeguarding the different sections of the amplifier and the loudspeaker enclosures has tripped due to an operating fault. In these cases, the power output is normally switched off until normal operating conditions are restored.

The following is a description of all the series protections

1) Switch on AC soft working Protection: Limit the electric current when start up, don't affect the others equipments or out the rush of circuit inside.

2) Delay the link load: protect the loudspeaker, keep silence when start up.

3) Circuit damage protection: midpoint excursion and output the AC, limit the damage to extend.

4) Limit the output current Soft protection: The loading impedance is low and too drastic signal; it can protect the loudspeaker and amplifier.

5) Clip and compress protection: When input too big signal, the clip output is distortion, it is easy to damage the speaker unit; this circuit can check the compress signal to protect the loudspeaker.

6) Short Circuit Protection: trips in the event of a short-circuit or overload, limiting the output current.

7) Over hot protection: In high temperature and low overload state, the temperature grow hot quickly, the protect will work to cut the load over 90°C. The amplifier will rework below 75°C.

8) Switch off Protection: First turn off the overload when switch off, it keep the loudspeaker silence out of the rush.



Some protection situations require the amplifier to be switched off and then back on for normal operating conditions be restored.

2 LIMITLEDS



Amplifier "status" indicators: these LEDS are able to indicate for channels A and B, the operation Of the internal limiter, when inserted, or the clipping of the amplifier:
 These 2 LEDS are POST-LEVEL: in other words they display the status of the signal when it has already been regulated by the input level controls.

3 SIGNALLEDS



Signal "status" indicators: these LEDS are able to indicate for channels A and B, a signal Presence in the inputs of the amplifier:

4 LEVEL



Control of the input level of the external signal: operates with continual values which vary From "fully closed" (position "MIN" - the signal is not fed to the amplifier sections) to "fully open" (position "MAX" - the signal is sent to the amplifier sections at the same level as that with which it arrives at the input). in other words, this control operates as an attenuator of the signal fed to the amplifier.

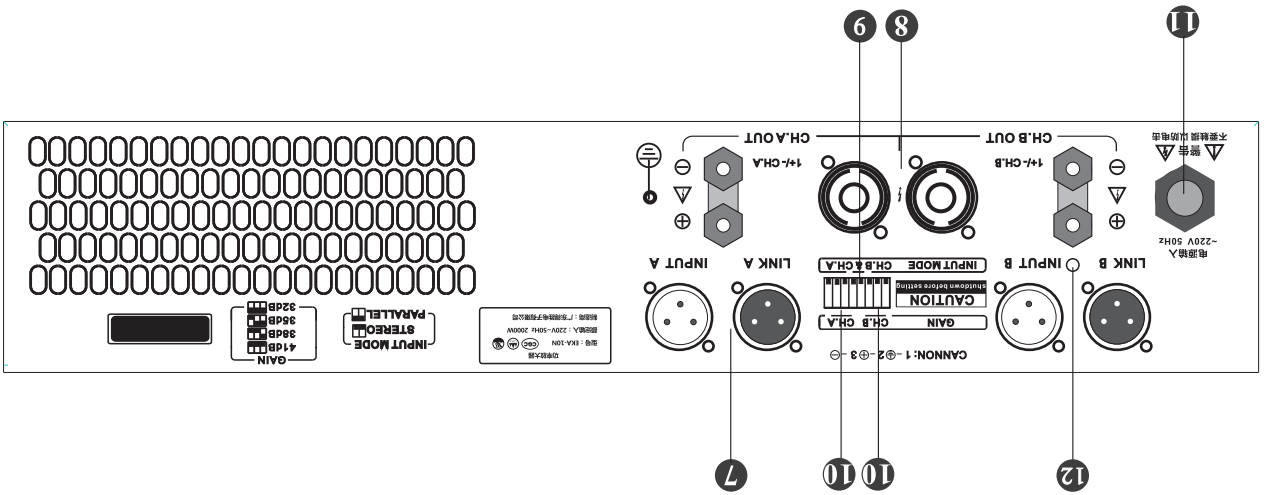

Rear Panel of TKA Series

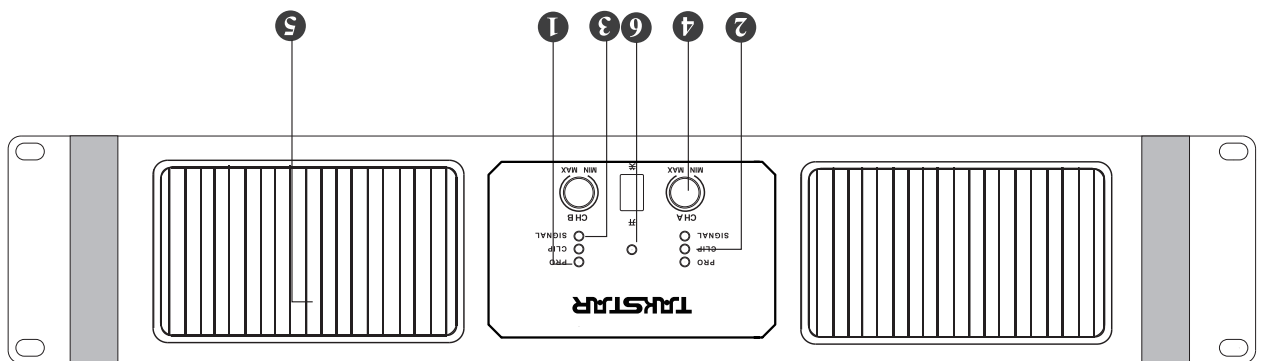

Front Panel of TKA Series

Installation & operating instruction

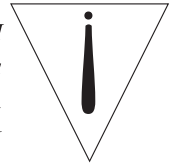

✓ **Mains power connection.** Before connecting the amplifier to the mains power socket, make certain that the voltage Corresponds with that indicated on the rear of the unit (AC220V ± 10%). Before connecting the power cable to the mains, always make certain that it is not damaged and that there are no bare wires, always connect the power cable to the amplifier before switching it on and only remove the cable after switching it off.

✓ **Switching on and off** In an audio system, it's always better to switch power amplifiers on last and off first. Remember to switch off the amplifier before connecting it to or disconnecting it from other units and to switch always on first the mixer and then the amplifier: in this manner, peaks which are annoying and sometimes dangerous particularly for the loudspeakers enclosures are avoided. It is normal for the LEDs to light up for a few moments when switching on.

✓ **Handling** Do not force knobs and connectors, as they could be damaged if treated with excessive force.

✓ **Connector cables** To connect the amplifier to the mixer, always make certain to use only signal cables (screened cables made up of two wires plus a braid screen), not power cables (speaker cables, normally made up of two wires, usually with a greater cross-section): to connect the amplifier to the loudspeaker enclosures, always use power cables, not signal cables, as in the latter case in fact, the power from the amplifiers would be partially disperse because of the cable's smaller cross-section. Take care of the connector cables. Always hold them by the connectors, avoiding pulling the wire and avoid knots and twists when coiling them: this gives the advantage of increasing their life and reliability.

✓ **Air circulation for cooling** Amplifier's correct cooling is ensured by internal fans, the speed of which is controlled by special sensors (the speed is proportional to output power, remember never to block the air vents in any way: the air necessary for cooling passes through these. If the amplifier is kept in a flight-case during use, make certain that it has sufficient openings at both the amplifier's air vents. Avoid locating it very small spaces which don't allow correct air circulation.

✓ **Warning High Voltage** Please attention fan-out high voltage, and polarity, not short circuit. When the product is work, don't touch the output connector for safety.

Catalogue 1

Installation & operating instruction 2

Functions & controls instruction 3

Technical specifications 7



CATALOGUE



IMPORTANT SAFETY INSTRUCTIONS

INSTRUCTIONS PERTAINING TO A RISK OF FIRE, ELECTRIC SHOCK OR INJURY TO PERSONS

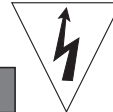
 CAUTION RISK OF ELECTRIC SHOCK DO NOT OPEN		
SHOCK. DO NOT REMOVE TOP OR BOTTOM COVER. NO USER SERVICEABLE PARTS INSIDE. REFER SERVICING TO QUALIFIED SERVICE PERSONNEL.		



The lightning flash with arrowhead symbol within an equilateral triangle is intended to alert the user to the presence of uninsulated "dangerous voltage" within the product's enclosure, that may be of sufficient magnitude to constitute a risk of electric shock to persons.

The exclamation point within an equilateral triangle is intended to alert the user to the presence of important operating and maintenance (Servicing) instruction in the literature accompanying the appliance.

WARNING-When using electric products, basic precautions should always be followed,

including the following:

1. Read all the **SAFETY INSTRUCTIONS** before using the product.
2. Please use the amplifier under the altitude of 2000 meters, and the non-tropical regions.
3. This product must be earthed. If it should malfunction or break down, grounding provides a path of least resistance for electric current to reduce risk of electric shock.

This product is equipped with a cord having an equipment-grounding conductor and a grounding plug. The plug must be plugged into an appropriate outlet that is properly installed and earthed in accordance with all local codes and ordinance.

DANGER-Improper connection of the equipment-grounding conductor can result in a risk of electric shock. Check with a qualified electrician or serviceman if you are in doubt as to whether the product is properly grounded. Do not modify the plug provided with the product-if it will not fit the outlet, have a proper outlet installed by a qualified electrician.

4. To reduce the risk of injury, close supervision is necessary when the product is used near children.
5. Do not use this product near water-for example, near a bathtub, washbowl, kitchen sink, in wet basement or near a swimming pool or the like.
6. This product may be capable of producing sound levels that could cause permanent hearing loss. Do not operate for a long period of time at high volume level or at a level that is uncomfortable. If you experience any hearing loss or ringing in the ears, you should consult an audiologist.
7. This product should be located so that its location or position does not interfere with its proper ventilation.
8. This product should be located away from heat sources such as radiators, heat registers or other products that produce heat.

9. The product should be connected to a power supply only of the type described on the operating instructions or as marked on the product.
10. This product may be equipped with a polarized line plug (one blade wider than the other). This is a safety feature. If you are unable to insert the plug into the outlet, contact an electrician to replace your obsolete outlet. Do not defeat the safety purpose of the plug.

11. The power-supply cord of the product should be unplugged from the outlet when left unused for a long period of time. When unplugging the power-supply cord, do not pull on the cord, but grasp it by the plug.
12. Care should be taken so that object do not fall and liquid are not spilled into the enclosure through openings.

13. The product should be serviced by qualified service personnel when:
 - A. The power-supply cord or the plug has been damaged; or
 - B. Objects have fallen, or liquid has been spilled into the product; or
 - C. The product has been exposed to rain;
 - D. The product does not appear to operate normally or exhibits a marked change in performance; or
 - E. The product has been dropped or the enclosure damaged.

14. Do not attempt to service the product beyond that described in the user-maintenance instructions. All other servicing should be referred to qualified service personnel.

15. **WARNING:** Do not place objects on the product's power cord or place it in a position where anyone could trip over, walk on or roll anything over it. Do not allow the product to rest on or to be installed over power cords of any type. Improper installations of this type create the possibility of fire hazard and or personal injury.

SAVE THESE INSTRUCTIONS

得胜 TDKSTAR®

TKA Series Professional Power Amplifier

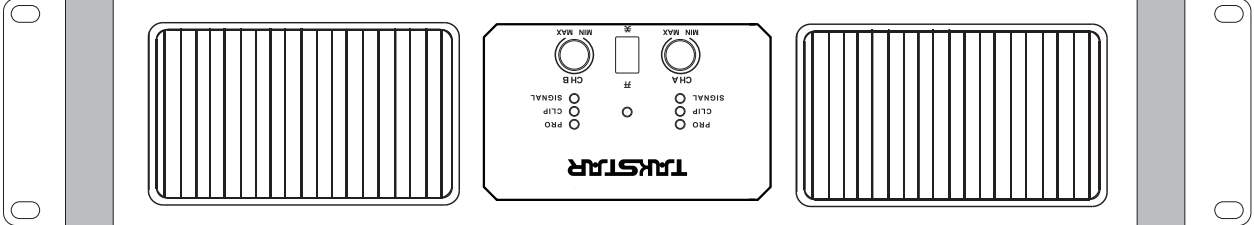

For your protection, please read the manual thoroughly, completely before operating the appliance and keep this manual for future reference.