

TAKSTAR® 得胜

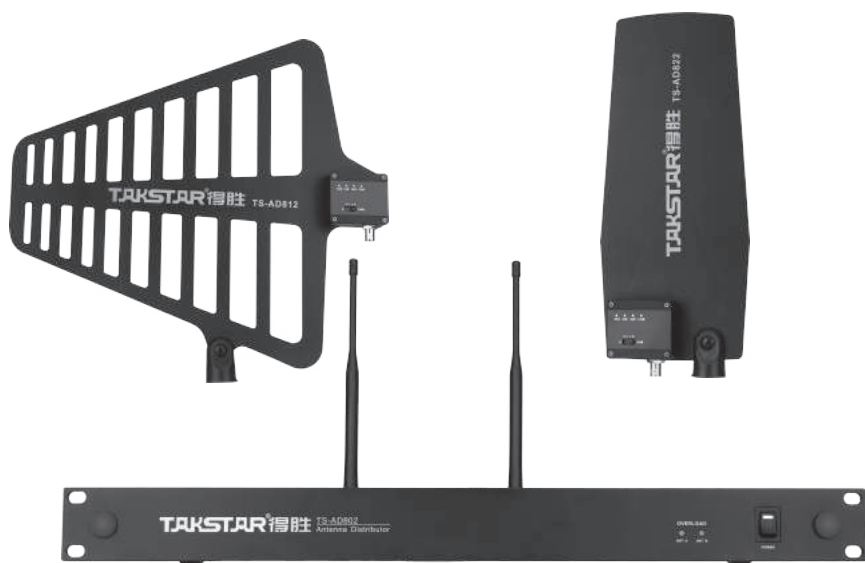

TS-AD系列天线系统 TS-AD Series Antenna System

使用手册 | User Manual

TS-AD系列天线系统

■ 前言

感谢您选购得胜TS-AD系列天线系统，为了您能够更好地了解使用本产品，建议您在使用前仔细阅读本说明书。

若存在有疑问或者您有宝贵的建议，可通过拨打得胜官方服务热线400 6828 333或微信扫描二维码关注得胜官方公众号与我们联系。



■ 产品特性

TS-AD802 天线信号分配器

- UHF宽频段（450~950MHz）设计，可实现4台接收机共用天线；
- 内置电源分配系统，可为4台接收机供电；
- 各电源端口设独立的保护电路，当其中一台接收机有故障时不会影响到其他机的正常工作；
- 总电源开关可统一控制所有设备的电源；
- 级联接口能够连接到第5套接收机或者第二台分配器；
- 附带前侧安装天线所需的硬件装置，使工程安装更方便简洁；
- 具有LED电源指示灯及信号指示灯，易于实时了解工作状态。

TS-AD812有源单指向天线

- UHF宽频段（450~950MHz）设计，内置信号放大器；
- 内置增益调节开关，可选择输出信号强度；
- 天线的前后比高，可有效抑制后方的干扰信号；
- 电源供电共用RF传输线，节约线材，方便使用。

TS-AD822有源全指向天线

- UHF宽频段（450~950MHz）设计，内置信号放大器；
- 内置增益调节开关，可选择输出信号强度；
- 全指向设计，可任意角度接收天线信号；
- 电源供电共用RF传输线，节约线材，方便使用；

TS-AD系列天线系统

■ 适用范围

户外演出、多功能厅等场景

■ 产品配置

| | |
|---------------|-----|
| TS-AD802..... | 1台 |
| 电源适配器..... | 1个 |
| 电源连接线..... | 4条 |
| 双头连接线..... | 10条 |
| UHF段天线..... | 2条 |
| BNC连接座..... | 2个 |
| 说明书..... | 1份 |

可另购配件:

| | |
|--------------------|----|
| TS-AD812指向性天线..... | 2支 |
| BNC连接线..... | 2条 |
| 说明书..... | 1份 |

可另购配件:

| | |
|--------------------|----|
| TS-AD822全指向天线..... | 2支 |
| BNC连接线..... | 2条 |
| 说明书..... | 1份 |

■ 技术参数

TS-AD802 天线信号分配器

- 频率响应: 450-950MHz
- 内部放大器增益: 6dB
- 输出接口隔离度: > 30dB
- 输入接口: BNC母座×2
- 输出接口: BNC母座×10
- 输入阻抗: 50Ω
- 输出阻抗: 50Ω
- 供电输出接口: DC插座*4 (每路提供600mA电流)
- 显示方式: 电源指示LED发光管*1, 信号指示双色发光管*2

TS-AD系列天线系统

- 电源要求：12V/3A直流电源适配器
- 工作温度范围：-10~+50°C
- 产品尺寸（长×宽×深）：482mm×45mm×175mm
- 产品重量：约2kg

TS-AD812有源单指向天线

- 频率范围：450-950MHz
- 天线增益：4-6dBi
- 指向性：单指向
- 有效角：100°
- 内部放大器增益：-6dB/0dB/6dB/12dB
- 驻波比：< 1.3
- 输出接口：BNC母座×1
- 显示方式：LED发光管×4
- 电源要求：BNC接头提供幻象供电8-15V/0.1A
- 工作温度范围：-10~+50°C
- 产品尺寸（长×宽）：355mm×345mm
- 产品重量：约320g

TS-AD822有源全指向天线

- 频率范围：450-950MHz
- 天线增益：0-2dBi
- 指向性：全指向
- 有效角：360°
- 内部放大器增益：-6dB/0dB/6dB/12dB
- 驻波比：< 1.3
- 输出接口：BNC母座×1
- 显示方式：LED发光管×4
- 电源要求：BNC接头提供幻象供电8-15V/0.1A
- 工作温度范围：-10~+50°C
- 产品尺寸（宽×高）：130mm×315mm
- 产品重量：约280g

注：以上数据由得胜实验室测试得到，并拥有最终解释权！

TS-AD系列天线系统

■ 功能示意

一、TS-AD802 天线信号分配器

前面板

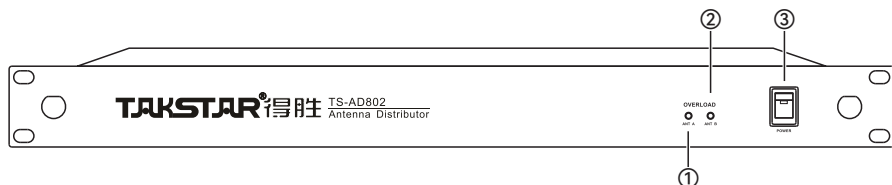

- ① 天线A射频过载指示灯：显示天线A射频信号强度，如射频功率过载，则指示灯显示绿色。
- ② 天线B射频过载指示灯：显示天线B射频信号强度，如射频功率过载，则指示灯显示绿色。
- ③ 电源开关：用于控制机内电源供应。

背面板

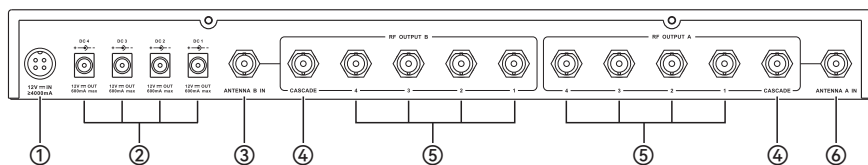

- ① 直流电源适配器插座：通过连接电源适配器，为机内提供电源。
- ② 电源分配连接座：将电源连接到接收机，方便简捷。
- ③ 天线B插座：用于连接外置天线。
- ④ 级联接口：可连接第五台接收机或第二台TS-AD802。
- ⑤ 天线分配连接座：将信号分别输送到接收机，增加接收距离。
- ⑥ 天线A插座：用于连接外置天线。

TS-AD系列天线系统

二、TS-AD812有源单指向天线

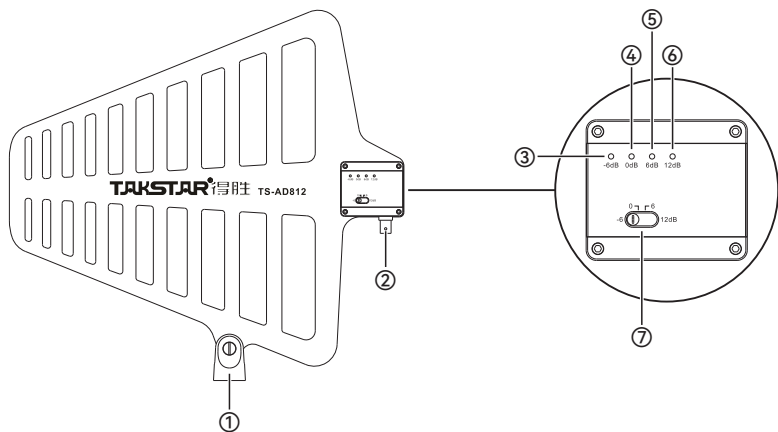

- ① 可调节底座
- ② BNC连接头
- ③ -6dB指示灯
- ④ 0dB指示灯
- ⑤ 6dB指示灯
- ⑥ 12dB指示灯
- ⑦ -6dB/0dB/6dB/12dB增益选择开关

三、TS-AD822有源全指向天线

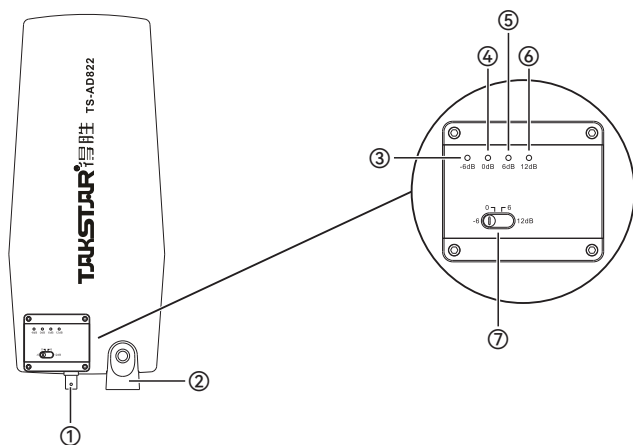

- ① BNC连接头
- ② 可调节底座
- ③ -6dB指示灯
- ④ 0dB指示灯
- ⑤ 6dB指示灯
- ⑥ 12dB指示灯
- ⑦ -6dB/0dB/6dB/12dB增益选择开关

TS-AD系列天线系统

■ 使用说明

一、单机连接收音机示意图



① BNC双头连接线

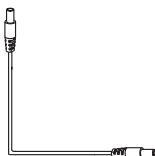

② 电源连接线

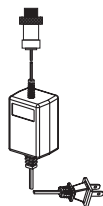

③ 直流电源适配器插座

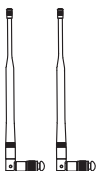

④ BNC橡胶天线



⑤ BNC连接座

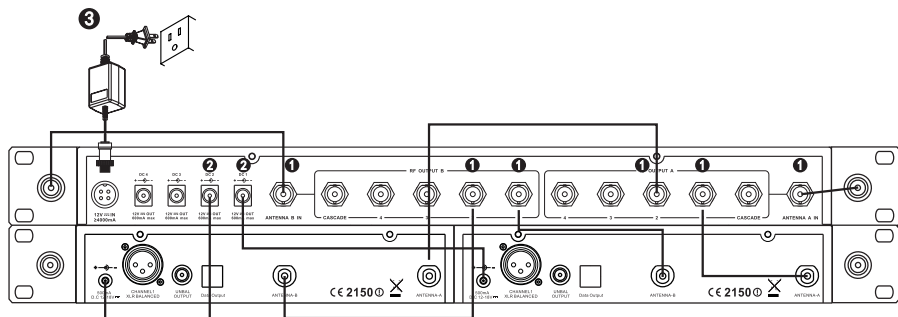
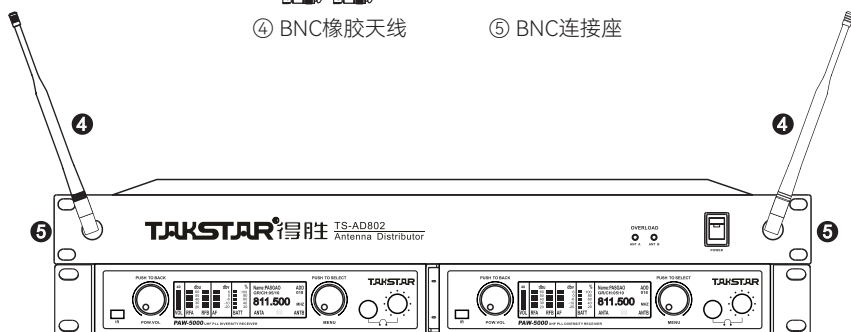

TS-AD系列天线系统

二、TS-AD812有源单指向天线与TS-AD802 天线信号分配器连接

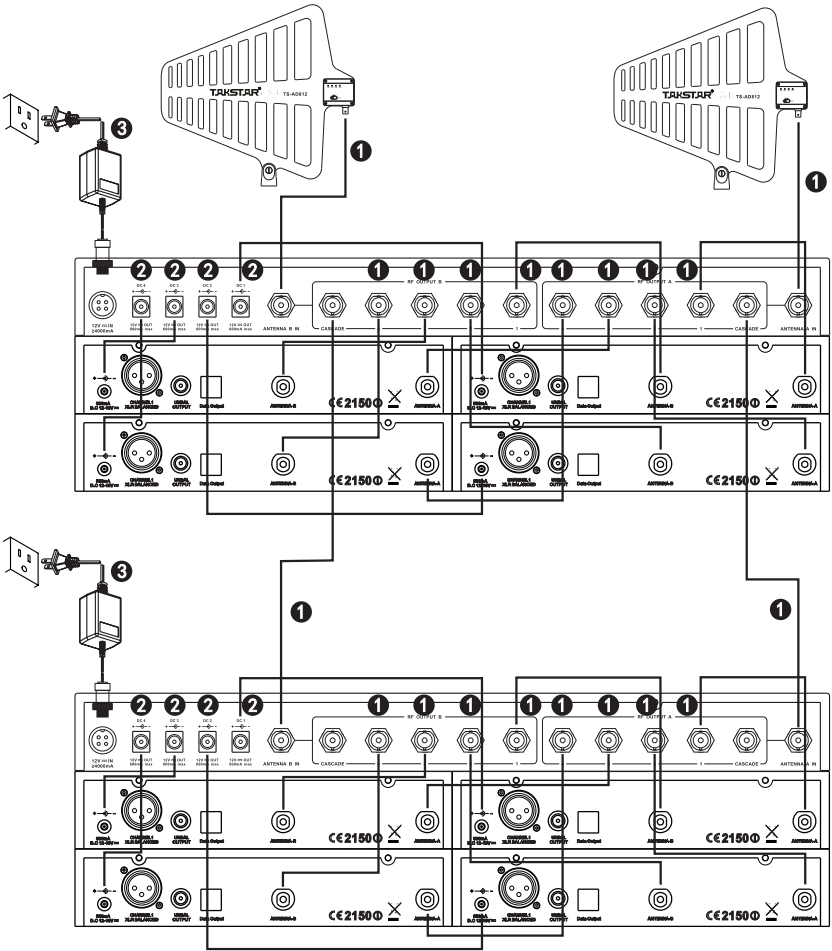

TS-AD系列天线系统

三、TS-AD822有源全指向天线与TS-AD802 天线信号分配器连接

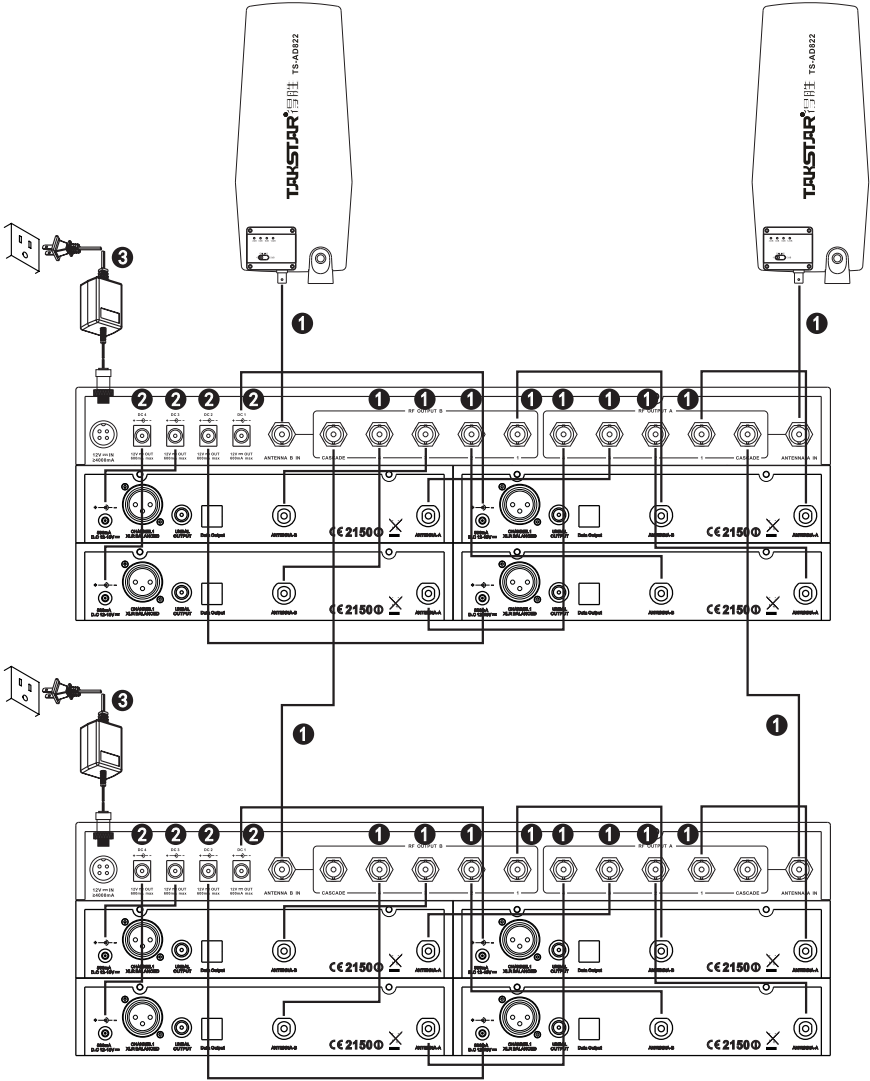

TS-AD系列天线系统

四、增益参数选项

根据所使用的同轴电缆的类型和长度，增益选择器需按照下表进行调节，以补偿信号路径造成的损失。

| 类型 | 电缆长度 | 建议增益 |
|------------------|--------|------|
| RG58 (直径5mm) | 3-8m | -6dB |
| | 9-14m | 0dB |
| | 15-20m | 6dB |
| | 21-26m | 12dB |
| RG223/U (直径5mm) | 5-15m | -6dB |
| | 16-25m | 0dB |
| | 26-35m | 6dB |
| | 36-45m | 12dB |
| RG223/U (直径10mm) | 10-30m | -6dB |
| | 31-45m | 0dB |
| | 46-64m | 6dB |
| | 65-80m | 12dB |

注：为获得理想的接收效果，建议天线的放置高度最低为1.8米。

五、天线安装

1. 可将带有螺纹的集成式支架轻松地固定到话筒支架上。注意：如果没有8-15V /0.1A偏压，天线将无法运行。
2. 使用配送线缆SYV50将天线连接到接收机或分配系统。
3. 只能将天线用于可提供8-15V直流偏压的接收机或分配系统。
4. 如果线缆长度较短，应降低增益设定；如果线缆长度较长应提高增益设定。应注意，讯号丢失不仅与线缆品质有关，还与线缆长度有关。RG316的1.5米线缆可能需要比3.0米低损耗线缆更高的增益。有关线缆信号损失的技术规格，请与线缆制造商联系。
5. 将天线对准需要覆盖的区域。
6. 不要将此天线用于发射信号。

六、线缆维护

为了让TS-AD812或TS-AD822保持理想性能，应注意下列事项：

1. 避免线缆扭弯或扭结。

TS-AD系列天线系统

2. 不要使用方便夹（例如用钉子环绕固定线缆）让线缆改变形状。
3. 不能长期工作在室外环境中。
4. 不能在高温高湿环境中使用。

七、天线放置

在固定天线时，应注意下列事项：

1. 天线和接收机必须使用同一频段。
2. 应将天线固定在彼此至少相距1.2米的位置。
3. 调整天线位置，让发射机在视线范围与天线之间没有障碍物（包括观众）。
4. 应让天线远离体积较大的金属物。

■ 安全警示

为避免电击、高温、着火、辐射、爆炸、机械危险以及使用不当等可能造成的人身伤害或财产损失，使用本产品前，请仔细阅读并遵守以下事项：

1. 使用产品时请确认所连设备与本产品是否匹配以及合理调整音量大小，不要在超过产品功率及大音量下长时间使用，以免造成产品异常；
2. 使用中若发现有异常（如冒烟、异味等），请立即关闭电源开关并拔掉电源插头，然后将产品送售后服务网点检修；
3. 若产品需要使用可拆装电池时，严禁使用外壳绝缘材料破损的电池，请不要为非充电电池充电；
4. 废弃电池需放入指定的分类垃圾桶，不可作为儿童玩具或直接丢弃，以免造成安全隐患或影响环境；
5. 本产品及配件都应放置在室内干燥通风处，勿长期存放在潮湿、灰尘多的环境，使用中避免靠近裸露火源、碰到液体物质、雨淋、产品进水、过度碰撞、抛掷、振动本机及覆盖通风孔，以免损坏其功能；
6. 若产品需要固定于墙壁或天花板上时，请确保固定到位，防止因固定强度不足导致产品发生跌落危险；
7. 使用该产品时需遵守相关安全规定，法律法规明确禁止使用场合请勿使用本机，以免导致意外事故；
8. 请不要自行拆机改装或维修，以防止出现人身伤害，如有问题或服务需求请联系当地售后服务网点跟进处理。

TS-AD系列天线系统

■ 关于本说明书

本说明书中内容符合截止印刷之日的技术规格。由于得胜公司会不断改进产品，本说明书可能不符合您的特定产品的技术规格。要获取最新版说明书，请访问得胜官网，然后下载说明书文件。技术规格、设备或另售的附件在各个地区可能有所不同，如有问题请与当地得胜销售网点确认。如需更多支持和深层产品信息，请浏览得胜官方网站：<https://www.takstar.com>

版权所有 ©2024 得胜。得胜、TAKSTAR及其各自标志是广东得胜电子有限公司在中国和/或其他国家/地区的注册商标或商标。所有其它商标均是其各自所有者的财产。

注意事项：

1. 本单为保修凭证，请用户妥善保管，如有遗失，恕不保修或退换。
2. 保修期限限制：购买之日起十二个月内。
3. 除了不可抗力事件损坏外，由本公司负责，免费维修。
4. 如属保管不善或使用不当造成的损坏，维修点将酌情收费。
5. 擅自拆卸维修者，不予保修。
6. 以上保修条款仅限于中国市场适用（不包含港澳台地区）。

产品服务保证书

姓名：_____ 电话：_____ 地址：_____

商品：_____ 型号：_____ 购买日期：_____ 年 _____ 月 _____ 日

| 维修记录栏（由维修员填写） | 维修员签名 | 日期 |
|---------------|-------|----|
| | | |
| | | |
| | | |
| | | |
| | | |
| | | |

◆广东得胜电子有限公司 ◆电话：400-6828-333 ◆地址：广东省惠州市博罗县龙溪街道富康一路2号

TS-AD Series Antenna System

■ Preface

Dear Customer,

Thank you for purchasing Takstar TS-AD Series Antenna System. To better understand and use the product, please read this manual thoroughly. If you have any questions or suggestions, please contact our local sales outlet.

■ Features

TS-AD802 Antenna Distributor

- UHF wide frequency range (450~950MHz), share antennas among 4 receivers.
- Built-in power distribution system supplies power to 4 receivers.
- Independent protection circuit for each power port prevents one receiver's malfunction from affecting others.
- Master power switch controls all device power.
- Cascading interface for connection to a fifth receiver or second distributor.
- Includes hardware for easy front-mounted antenna installation.
- LED power and RF signal indicators for real-time status monitoring.

TS-AD812 Active Directional Antenna

- UHF wide frequency range (450~950MHz) with built-in signal amplifier.
- Built-in gain selector switch for choosing output signal strength.
- High front-to-back ratio effectively suppresses rear interference signals.
- Power supply shares RF transmission line, less wiring, more convenience.

TS-AD822 Active Omnidirectional Antenna

- UHF wide frequency range (450~950MHz) with built-in signal amplifier.
- Built-in gain selector switch for choosing output signal strength.
- Omnidirectional design for receiving signals from any angle.
- Power supply shares RF transmission line, less wiring, more convenience.

TS-AD Series Antenna System

■ Applications

For outdoor performances, multifunctional halls, and similar venues.

■ Package Contents

| | | |
|----------------------|-------------------|----------------------------|
| 1 × TS-AD802 | 1 × Power Adapter | 4 × Power Connection Cable |
| 10 × Dual-Head Cable | 2 × UHF Antenna | 2 × BNC Connector |
| 1 × User Manual | | |

Optional Accessory Purchase:

| | | |
|----------------------------------|---------------|-----------------|
| 2 × TS-AD812 Directional Antenna | 2 × BNC Cable | 1 × User Manual |
|----------------------------------|---------------|-----------------|

Optional Accessory Purchase:

| | | |
|----------------------------------|---------------|-----------------|
| 2 × TS-AD822 Directional Antenna | 2 × BNC Cable | 1 × User Manual |
|----------------------------------|---------------|-----------------|

■ Specifications

TS-AD802 Antenna Distributor

- Frequency Response: 450–950MHz
- Internal Amplifier Gain: 6dB
- Output Interface Isolation: >30dB
- Input Interface: 2 × BNC Female
- Output Interface: 10 × BNC Female
- Input Impedance: 50Ω
- Output Impedance: 50Ω
- Power Output Interface: 4 × DC Socket (600mA current per channel)
- Display: 1 × Power Indicator LED, 2 × Signal Indicator Bicolor LED
- Power Requirements: 12V/3A DC Power Adapter
- Operating Temperature Range: -10 ~ +50°C
- Product Dimensions (L × W × D): 482mm × 45mm × 175mm
- Product Weight: Approximately 2kg

TS-AD Series Antenna System

TS-AD812 Active Directional Antenna

- Frequency Range: 450-950MHz
- Antenna Gain: 4-6dBi
- Directivity: Unidirectional
- Effective Angle: 100°
- Internal Amplifier Gain: -6dB/0dB/6dB/12dB
- VSWR: <1.3
- Output Interface: 1 × BNC Female
- Display: 4 × LED Indicator
- Power Requirements: Phantom power supply via BNC connector, 8-15V/0.1A
- Operating Temperature Range: -10 ~ +50°C
- Product Dimensions (L × W): 355mm × 345mm
- Product Weight: Approximately 320g

TS-AD822 Active Omnidirectional Antenna

- Frequency Range: 450-950MHz
- Antenna Gain: 0-2dBi
- Directivity: Omnidirectional
- Effective Angle: 360°
- Internal Amplifier Gain: -6dB/0dB/6dB/12dB
- VSWR: <1.3
- Output Interface: 1 × BNC Female
- Display: 4 × LED Indicator
- Power Requirements: Phantom power supply via BNC connector, 8-15V/0.1A
- Operating Temperature Range: -10 ~ +50°C
- Product Dimensions (W × H): 130mm × 315mm
- Product Weight: Approximately 280g

Note: The above data are measured by Takstar laboratory which has the final interpretation right!

TS-AD Series Antenna System

■ Function Descriptions

I. TS-AD802 Antenna Distributor

Front Panel

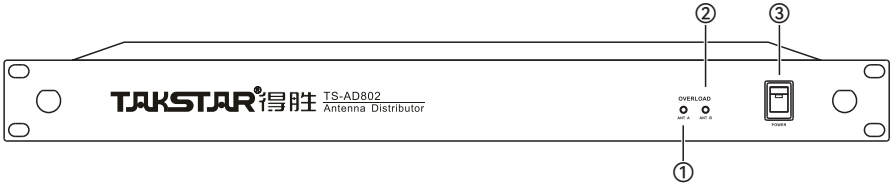

- ① Antenna A RF Overload Indicator: Displays strength of RF signal from Antenna A. The indicator will show green if the RF power is overloaded.
- ② Antenna B RF Overload Indicator: Displays strength of RF signal from Antenna B. The indicator will show green if the RF power is overloaded.
- ③ Power Switch: Controls power supply within the unit.

Rear Panel

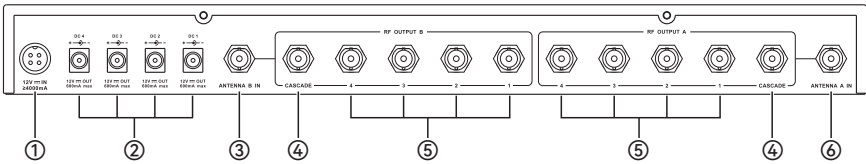

- ① DC Power Adapter Socket: Provides power to the unit by connecting the power adapter.
- ② Power Distribution Connectors: Supplies power to receivers for convenient and easy setup.
- ③ Antenna B Connector: Used to connect external antennas.
- ④ Cascading Interface: Can be connected to a fifth receiver or a second TS-AD802.
- ⑤ Antenna Distribution Connectors: Distribute signals to receivers individually, extending reception distance.
- ⑥ Antenna A Connector: Used to connect external antennas.

TS-AD Series Antenna System

II. TS-AD812 Active Directional Antenna

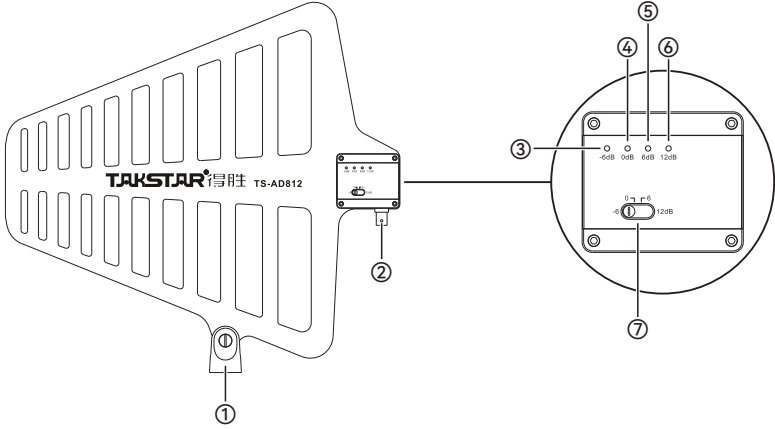

- ① Swivel Bracket
- ② BNC Connector
- ③ -6dB Indicator
- ④ 0dB Indicator
- ⑤ 6dB Indicator
- ⑥ 12dB Indicator
- ⑦ -6dB/0dB/6dB/12dB Gain Selector Switch

III. TS-AD822 Active Omnidirectional Antenna

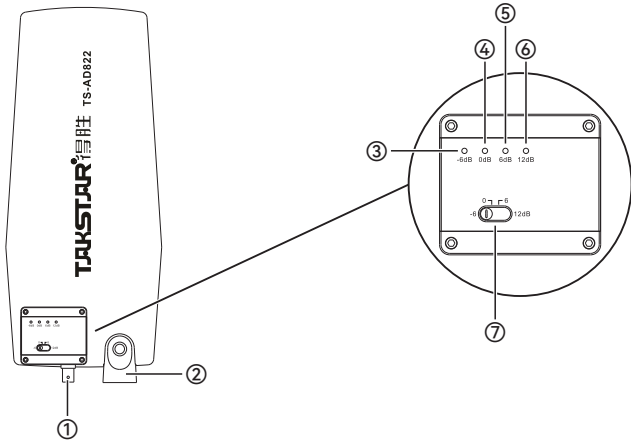

- ① BNC Connector
- ② Swivel Bracket
- ③ -6dB Indicator
- ④ 0dB Indicator
- ⑤ 6dB Indicator
- ⑥ 12dB Indicator
- ⑦ -6dB/0dB/6dB/12dB Gain Selector Switch

TS-AD Series Antenna System

■ Operating Instructions

I. Single Distributor Connection Diagram

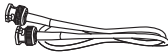

① BNC Dual-Head Cable

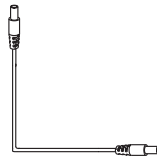

② Power Connection Cable



③ DC Power Adapter Socket

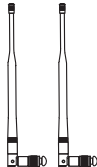

④ BNC Rubber Antenna



⑤ BNC Connector

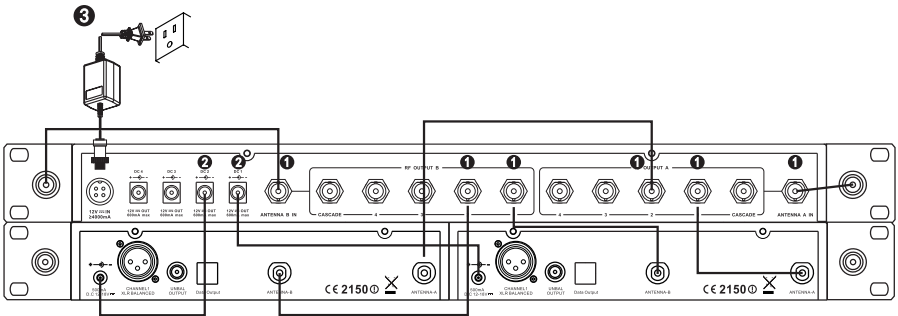
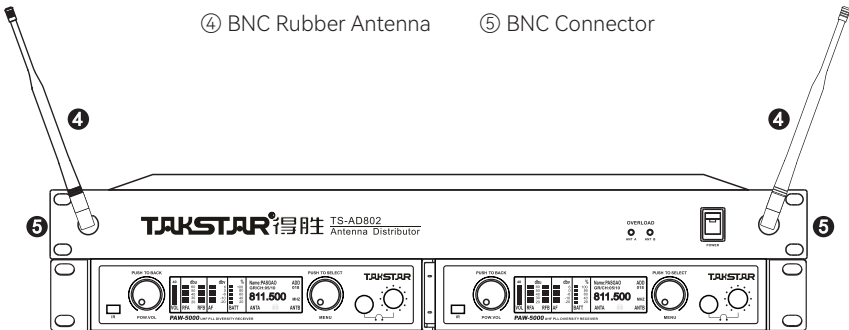

TS-AD Series Antenna System

II. Connection between TS-AD812 Active Directional Antenna and TS-AD802 Antenna Distributor

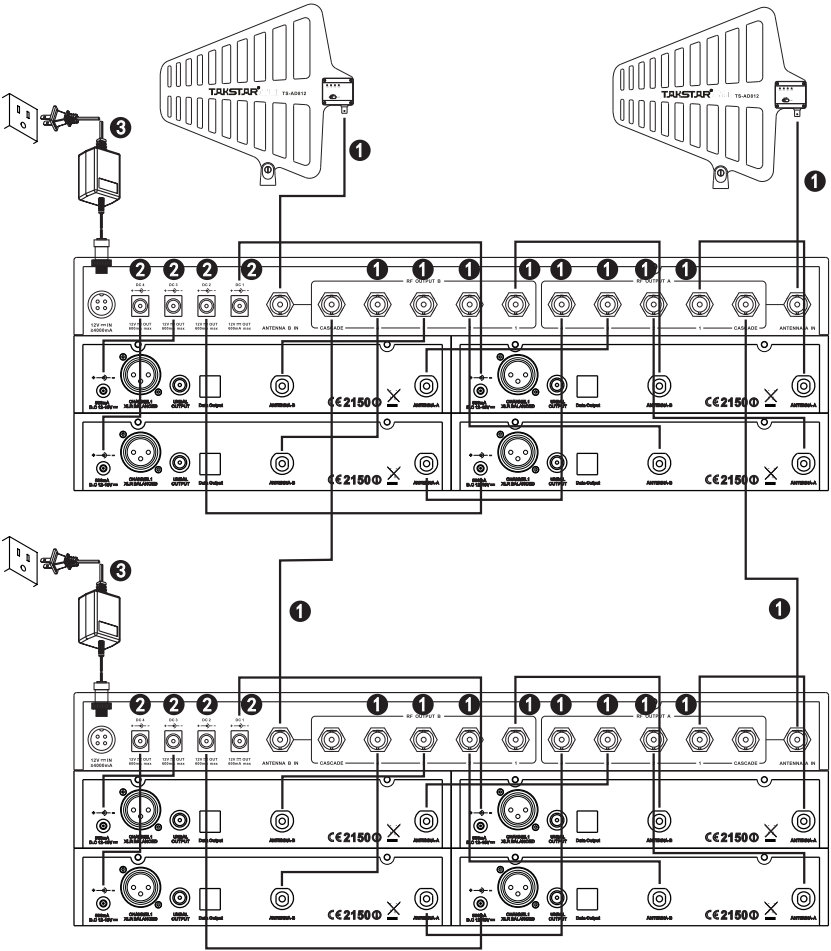

TS-AD Series Antenna System

III. Connection between TS-AD822 Active Omnidirectional Antenna and TS-AD802 Antenna Distributor

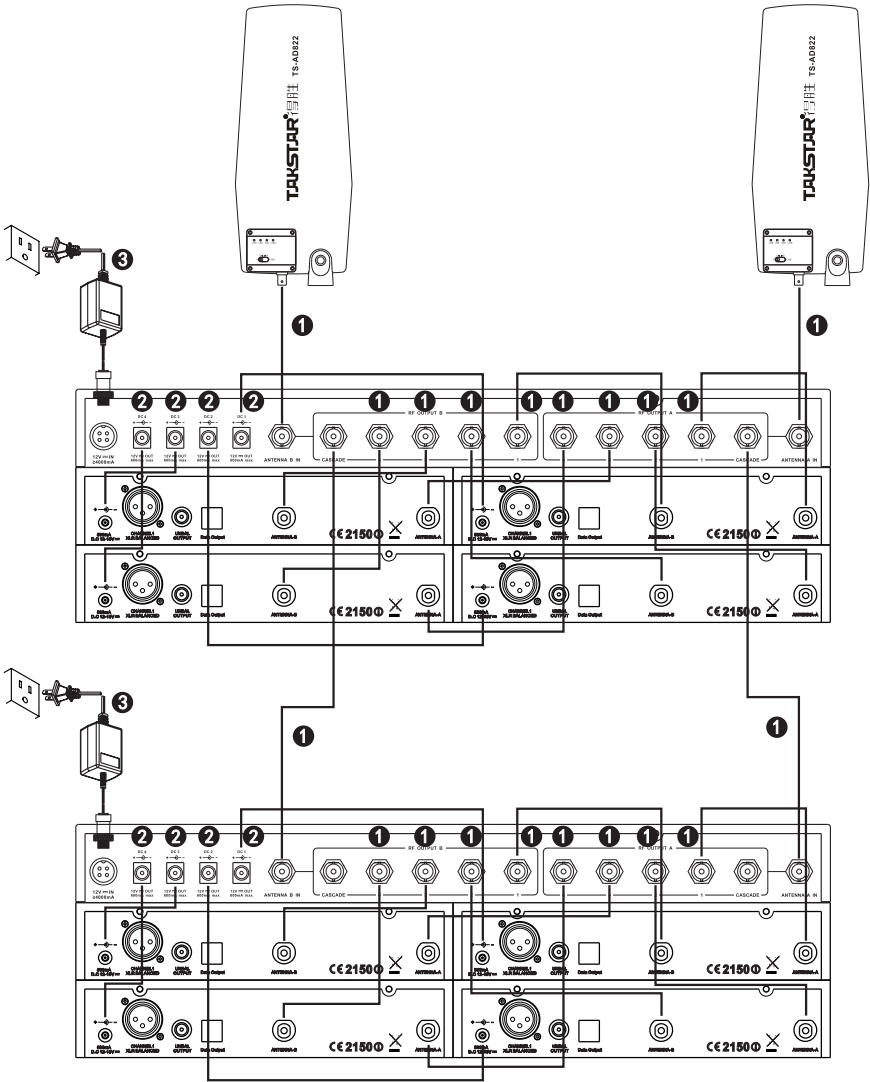

TS-AD Series Antenna System

IV. Gain Parameter Options

Based on the type and length of the coaxial cable used, adjust gain selector according to the table below to compensate for signal path losses.

| Type | Cable Length | Recommended Gain |
|------------------|--------------|------------------|
| RG58 (Ø 5mm) | 3-8m | -6dB |
| | 9-14m | 0dB |
| | 15-20m | 6dB |
| | 21-26m | 12dB |
| RG223/U (Ø 5mm) | 5-15m | -6dB |
| | 16-25m | 0dB |
| | 26-35m | 6dB |
| | 36-45m | 12dB |
| RG223/U (Ø 10mm) | 10-30m | -6dB |
| | 31-45m | 0dB |
| | 46-64m | 6dB |
| | 65-80m | 12dB |

Note: For optimal reception, it is recommended to place the antennas at a minimum height of 1.8 meters.

V. Antenna Installation

1. Secure the integrated threaded adapter onto a mic stand. Note: The antenna will not function without a bias voltage of 8-15V/0.1A.
2. Use the distribution cable SYV50 to connect the antenna to the receiver or distribution system.
3. The antenna only operates with receivers or distribution systems that provide 8-15V DC bias voltage.
4. Lower the gain setting for short cable runs, or increase gain for longer runs. Note that the quality of the cable, not just the length, contributes to signal loss. RG316 cable with a length of 1.5 meters may require a higher gain than low-loss cables of 3.0 meters. Contact the cable manufacturer for cable loss specifications.
5. Aim the antenna towards the desired coverage area.
6. Do not use this antenna for transmitting signals.

TS-AD Series Antenna System

VI. Cable Maintenance

To maintain ideal performance for antennas:

1. Avoid sharp bending or twisting the cables.
2. Do not use clamps or fasteners that alter the shape of the cables.
3. Do not use in outdoor environments for extended periods.
4. Do not use in high-temperature or high-humidity environments.

VII. Antenna Placement

When positioning antennas, please consider the following:

1. The antenna and receiver must operate within the same frequency range.
2. Place antennas at least 1.2 meters apart from each other.
3. Position antennas so there is nothing obstructing a line of sight to the transmitter (including the audience).
4. Keep antennas away from large metal objects.

■ Safety Instructions

To avoid electric shock, overheat, fire, radiation, explosion, mechanical risk and injury or property loss due to improper use, please read and observe the following items before use:

1. Please check if the power of the connected equipment matches with that of this product before operation. Adjust the volume to proper level during operation. Do not operate at over-power or high-volume level for extended time to avoid product malfunction or hearing impairment.
2. If there is any abnormality during use (e.g., smoke, strange odor), please kill the power switch and unplug from power source, then send the product to the local after-sales service for repair.
3. Never use any replacement battery with broken insulation. Do not charge non-chargeable battery.
4. Dispose waste batteries in designated dustbin for sorting. Do not use them as children's toy nor discard directly to avoid health risk or environmental damage.
5. Keep this product and its accessories in a dry and ventilated area. Do not store in a humid or dusty area for extended time. Keep away from fire, rain, liquid intrusion, bumping, throwing, vibrating, or from blocking any ventilation openings, to prevent malfunction.
6. The product must, when installed on walls or ceilings, be fixed firmly in place at adequate strength to prevent from falling.

TS-AD Series Antenna System

7. Please abide by safety rules during operation. Do not use the product in places prohibited by laws or regulations to avoid accident.

8. Do not disassemble or repair the product by yourself to avoid injury. If you have any questions or require any services, please contact our local after-sales service.

■ About This Manual

This manual contains up-to-date technical specifications as of printing. However, specifications contained herein may not conform to your particular product since Takstar is constantly improving its products. Also, specifications, devices or accessories available may vary from region to region. If you have any questions, please contact our local sales outlet. For the latest version/more information, please visit our website: <https://www.takstar.com/>

Copyright ©2024 TAKSTAR. TAKSTAR, 得胜 and their respective logos are registered trademarks or trademarks of Guangdong Takstar Electronic Co., Ltd. in the PRC, and/or other countries. All other trademarks are the property of their respective owners.



扫一扫，了解更多产品
Scan for more
product information

广东省电声工程技术研究中心 广东得胜电子有限公司制造

地址：广东省惠州市博罗县龙溪街道富康一路2号

服务热线：400 6828 333 传真：0752 6383950

邮箱：xs@takstar.com

网址：www.takstar.com

Guangdong Takstar Electronic Co., Ltd.

Address: No. 2 Fu Kang Yi Rd., Longxi Boluo

Huizhou, Guangdong 516121 China

Tel: 86 752 6383644 Fax: 86 752 6383952

Email: sales@takstar.com

Website: www.takstar.com