

TAKSTAR® 得胜



WPM-580
无线监听耳机
Wireless Monitor Headphones

使用手册 | User Manual

■ 前言

尊敬的用户：

感谢您选购得胜WPM-580无线监听耳机，为了您能够更好的了解使用本产品，建议您在使用前仔细阅读本使用手册。

若存在有疑问或者您有宝贵的建议，可通过拨打得胜官方服务热线400 6828 333或微信扫描二维码关注得胜官方公众号与我们联系。



■ 产品特性

- 一款颈挂式无线监听耳机，专为直播监听、录音监听等场合设计；
- 采用5.8G无线传输技术，连接和传输信号稳定，可达15米以上传输距离；
- 无线一拖多，可实现N个耳机同步监听，一键配对，多人分享；
- 专业录音监听级别的超低延迟，音画同步，直播互动更流畅；
- 快速配对，自动回连，无需繁琐的配对操作；
- 48kHz采样率，立体声高清音质，音乐细节饱满动感；
- 颈挂式设计，小巧轻便，佩戴舒适，载歌载舞轻松自如；
- 发射器采用 Φ 3.5mm音频输入接口，方便与声卡、调音台等音频设备连接；
- 内置锂电池，持久续航，充电2小时，可以持续使用约6小时。

■ 适用范围

- 适用于直播监听、录音监听、直播带货等场合

■ 产品配置

WPM-580无线监听耳机

- 无线耳机.....1只
- 发射器.....1只
- Y型Type-C充电线.....1条
- 使用手册.....1份

WPM-580R无线监听耳机

- 无线耳机.....1只
- Type-C充电线.....1条
- 使用手册.....1份

■ 技术参数

发射器参数

- 电池容量：3.7V/750mAh
- 充电电压/电流：DC 5V/500mA
- 充电方式：USB 5V/500mA
- 充电时间：约2小时
- 工作续航时间：约6小时
- 单体重量的：约37g

无线耳机参数

- 电池容量：3.7V/750mAh
- 充电电压/电流：DC 5V/500mA
- 充电方式：USB 5V/500mA
- 充电时间：约2小时
- 工作续航时间：约6小时
- 单体重量的：约50g

综合参数

- 工作频率: 5.8GHz
- 单元类型: 动圈单元
- 单元直径: Ø14.2mm
- 频率响应: 20Hz-20kHz
- 阻抗: 40Ω
- 灵敏度: 103±3dB
- 采样率: 48kHz/24bit
- 峰值功率: 38mW
- 额定功率: 30mW
- 信噪比: 85dB (A-Weighted)
- 总谐波失真: THD<0.5%1KHz
- 传输距离(无障碍空旷地带): 15米
- 连接类型: 3.5mm三极插头

注:以上数据由得胜实验室测试得到,并拥有最终解释权!

充电时间和使用时间可能会因使用状况存在差异。

传输范围将视设备之间的障碍物、微波炉周围的磁场、静电等因素而变化。

■ 功能示意

发射器

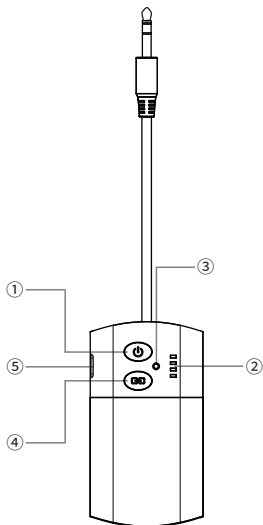

- ① 电源键：长按该按键2秒开机或关机，开机自动进入回连状态。
- ② 电源指示灯：共4格指示灯，每格代表25%电量。剩下一格时，指示灯绿灯闪烁，表示电量不足需及时充电；充电时，指示灯呈逐格流水点亮，充满后绿灯满格常亮显示。
- ③ 配对指示灯：进入配对模式工作指示灯绿灯快闪，配对完成后恢复常亮。
- ④ 配对键：开机状态下，长按该按键5秒，手动进入配对状态。
- ⑤ Type-C充电接口：通过充电线连接5V/500mA以上适配器充电。

无线耳机

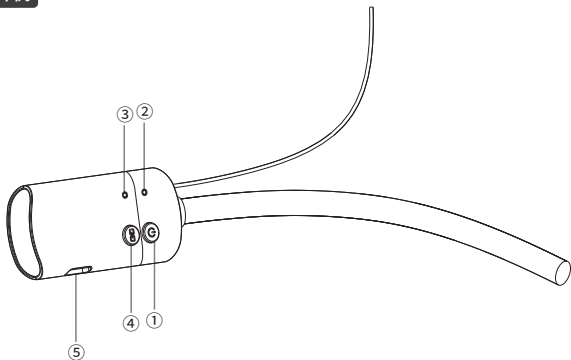

- ① 电源键：长按该按键2秒开机或关机，开机自动进入回联状态。
- ② 电源指示灯：充电时，绿灯常亮，充满电后熄灭。
- ③ 配对指示灯：配对时工作指示灯快闪，配对完成后恢复常亮。
- ④ 配对键：开机状态下，长按该按键5秒，手动进入配对状态。
- ⑤ Type-C充电接口：通过充电线连接5V/500mA以上适配器充电。

■ 使用说明

配对操作

套装出厂时已默认配对好，开机会自动连接，如需重新配对或配对更多无线耳机时，可按照以下方法进行配对：

- 1.发射器：开机状态下，长按发射器配对键5秒，进入配对状态，配对指示灯快闪；
- 2.无线耳机：开机状态下，长按接收器配对键5秒，进入配对状态，配对指示灯快闪；

- 3.发射器和无线耳机配对指示灯均常亮时，表示配对完成连接成功；
 - 4.增加多只无线耳机配对连接时，按照上述步骤重复操作，即可实现一拖多功能。
- 注：若多套设备配对时，请避免多套发射器同时进入配对模式，错开时段单独配对。

监听连接方法

- 1.发射器和无线耳机配对成功后，将发射器连接到声卡的 $\Phi 3.5\text{mm}$ 监听耳机接口；

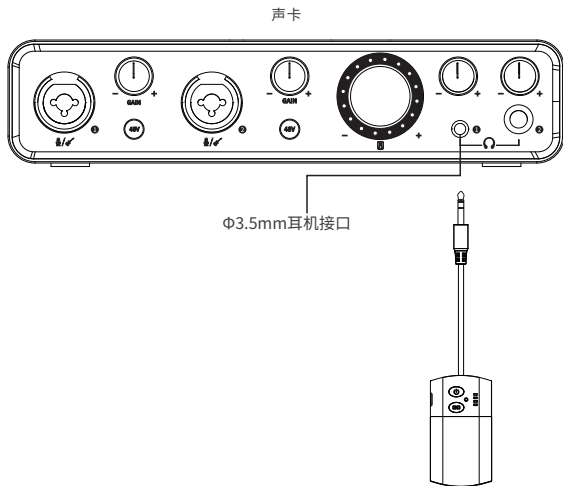

2.如声卡设备的监听耳机接口为 $\Phi 6.35\text{mm}$ 规格，请使用 $\Phi 3.5\text{mm}$ 转 6.35mm 转接头（转接头需自行另购）进行连接。

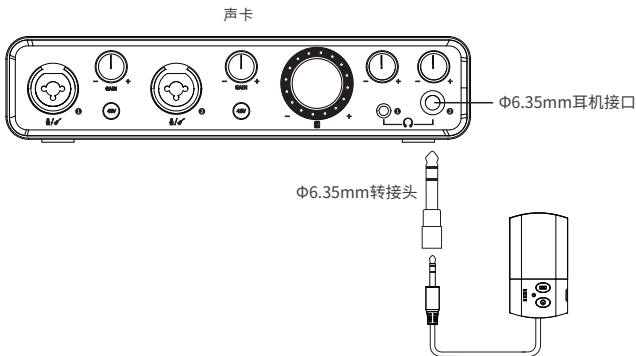

■ 安全使用说明

为了您有一个安全与舒适的体验，请仔细阅读并遵守以下事项：

1. 为了避免听力受损，请务必在连接耳机前将播放设备音量调小。在将耳机佩戴入耳内/耳上之后，再逐步调大至您聆听舒适的音量。噪音是以分贝（dB）为计量单位的，外界任何85分贝及以上的噪音都会导致听力逐渐受损。
2. 请注意您的使用习惯。音量和时间对听力损失的影响成正比的关系，音量越大，您的聆听时间越短；音量越舒适，您聆听的时间越长。长时间使用较高的音量会对您的听力造成损伤。

以下分贝 (dB) 表对某些常见声音进行比较, 并列出了它们可能对听力的潜在危害等级。

声音来源	噪声等级	听力影响
细声低语	30dB	非常安静
安静的办公室	50-60dB	舒适的听力级别在60dB以下
吸尘器/吹风机	70dB	有一定入侵性, 造成干扰妨碍电话交谈
食物料理机	85-90dB	85dB是开始造成听力受损 (连续8小时) 的级别
垃圾清理机 混凝土搅拌机	100dB	建议无保护措施而暴露在90-100dB声音之下的时间不要超过15分钟
电锯/电钻	110dB	经常暴露于超过100dB的声音1分钟以上会有听力受损的风险
摇滚音乐会 (因情况而异)	110-140dB	感觉疼痛的阈值在120dB左右开始

■ 维护及保养

- 1.请储存于干燥洁净环境, 使用中避免液体进入耳机内部、跌落或碰撞, 以免损坏;
- 2.勿在高温高湿的场所长时间使用耳机, 容易造成耳机损坏或降低使用寿命;
- 3.耳机在放置时要避免与强磁体接触, 以免耳机的恒磁体去磁, 使耳机的灵敏度降低而影响影响耳机音色;
- 4.勿使用烈性化学制品、清洁剂, 清洁耳机;
- 5.不要用尖锐物品在产品表面刮蹭, 以免损坏外壳、影响外观;
- 6.耳机长时间不使用时, 应存放在干燥清洁的地方, 避免在温度过高或过度潮湿的场所保管或使用;

■ 注意事项

⚠ 危险

• 为确保您的人身安全，请勿将该耳机佩戴或放置在离心脏起搏器过近的位置(小于10cm)。	⊘ 禁止
• 请勿将线材插头插入电源插座。	⊘ 禁止
• 为了您与其他交通参与者的安全，驾驶车辆、骑自行车或马路上行走时，请勿使用耳机。	Ⓛ 执行
• 请勿将耳机靠近明火或置于火中，以免发生爆炸。	⊘ 禁止

⚠ 警告

• 儿童应在成人监督下使用本产品，本产品并非玩具。	Ⓛ 执行
• 使用该产品时需遵守相关安全规定，法律法规明确禁止使用场合请勿使用本机，以免导致意外事故。	Ⓛ 执行

■ 安全警示

为避免电击、高温、着火、辐射、爆炸、机械危险以及使用不当等可能造成的人身伤害或财产损失，使用本产品前，请仔细阅读并遵守以下事项：

1. 使用产品时请确认所连设备与本产品是否匹配以及合理调整音量大小，不要在超过产品功率及大音量下长时间使用，以免造成产品异常和听力损伤；
2. 使用中若发现有异常（如冒烟、异味等），请立即关闭电源开关并拔掉电源插头，然后将产品送售后服务网点检修；
3. 本产品及配件都应放置在室内干燥通风处，请勿长期存放在潮湿、灰尘多的环境，使用中避免靠近火源、雨淋、进水、过度碰撞、抛掷、振动本机及覆盖通风孔，以免损坏其功能；
4. 建议在正常温度范围内使用耳机，温度过高或过低的使用环境可能会引起设备故障；

5. 使用该产品时需遵守相关安全规定，法律法规明确禁止使用场合请勿使用产品，以免导致意外事故；
6. 请不要自行拆机改装或维修，以防止出现人身伤害，如有问题或服务需求请联系当地售后服务网点跟进处理，未经同意对本产品进行自行拆机改装或维修，可能会失去由得胜电子有限公司提供的保修。

■ 环保说明

产品中有毒有害物质或元素的名称及含量标识表

部件名称	有毒有害物质或元素					
	铅 (Pb)	汞 (Hg)	镉 (Cd)	六价铬 (Cr(VI))	多溴联苯 (PBB)	多溴二苯醚 (PBDE)
塑料部件	○	○	○	○	○	○
金属部件	×	○	○	○	○	○
电路板组件	×	○	○	○	○	○
线缆	×	○	○	○	○	○

本表格依据SJ/T 11364的规定编制。
○: 表示该有害物质在该部件所有均质材料中的含量均在 GB/T 26572 规定的限量要求以下。
×: 表示该有害物质至少在该部件的某一均质材料中的含量超出 GB/T 26572 规定的限量要求。

此标志为产品的环保使用期限标志，
且此标保使用期限只适用于产品正常工作的温度和湿度等条件。

电池部份的环保使用期限为5年。



■ 关于图标含义解释



此符号表示，根据WEEE指令(2012/19/EU)和国家法律，由于这种类型的
■ 废弃物会有潜在的有害物质，可能对环境 and 人类健康产生负面影响，所以
本产品不应与您的家庭垃圾一起处置，应将本产品交由授权的电气和电子设备
(WEEE)回收站回收。同时，您在正确处理本产品的同时将有助于自然资源的
有效利用。如需了解更多有关您可以在何处放置废物回收设备的信息，请联系您
当地的城市办事处、废物管理局或家庭废物处理服务部门。

■ 关于本使用手册

本使用手册中内容符合截止印刷之日的技术规格。由于得胜公司会不断改进
产品，本使用手册可能不符合您的特定产品的技术规格。要获取最新版使用手册，
请访问得胜官网，然后下载使用手册文件。技术规格、设备或另售的附件在各个
地区可能有所不同，如有问题请与当地得胜销售网点确认。如需更多支持和深层
产品信息，请浏览得胜官方网站：<https://www.takstar.com>

版权所有 ©2023 得胜。得胜、TAKSTAR及其各自标志是广东得胜电子有限公司
在中国和/或其他国家/地区的注册商标或商标。所有其它商标均是其各自所有者
的财产。

■ Preface

Dear Customer,

Thank you for purchasing Takstar WPM-580 Wireless Monitor Headphones. To better understand and use the product, please read this manual carefully. If you have any questions or suggestions, please contact our local dealer.

■ Features

- Wireless neckband headphones tailored for live monitoring, recording monitoring, and similar occasions.
- Utilizes 5.8GHz wireless technology for stable transmission up to 15 meters.
- Wireless multi-link capability allows for synchronous monitoring with multiple headphones.
- Studio-level ultralow latency for seamless monitoring of your live stream.
- Quick pairing and automatic reconnection eliminate the need for cumbersome pairing operations.
- High-definition stereo sound quality with 48kHz sampling rate, delivering rich and immersive music details.
- Compact and lightweight neckband design for comfortable wearing during performances and activities.
- \varnothing 3.5mm audio input on transmitter for convenient connection with audio interfaces, mixers, and other audio devices.
- Built-in lithium battery provides about 6 hours of runtime after 2-hour charging.

■ Application

- Live monitoring, recording monitoring, and live e-commerce.

■ Package Contents

WPM-580 Wireless Monitor Headphones

- Wireless Headphones1 PR.
- Transmitter1 PC.
- Y Splitter Type-C Charging Cable1 PC.
- User Manual1 PC.

WPM-580R Wireless Monitor Headphones

- Wireless Headphones1 PR.
- Type-C Charging Cable1 PC.
- User Manual1 PC.

■ Specifications

Transmitter

- Battery Capacity: 3.7V/750mAh
- Charging Voltage/Current: DC 5V/500mA
- Charging Method: USB 5V/500mA
- Charging Time: Approx. 2 hours
- Battery Life: Approx. 6 hours
- Weight: Approx. 37g

Wireless Headphones

- Battery Capacity: 3.7V/750mAh
- Charging Voltage/Current: DC 5V/500mA
- Charging Method: USB 5V/500mA
- Charging Time: Approx. 2 hours
- Battery Life: Approx. 6 hours
- Weight: Approx. 50g

Overall System

- Operating Frequency: 5.8GHz
- Driver Type: Dynamic driver
- Driver Diameter: \varnothing 14.2mm
- Frequency Response: 20Hz-20kHz
- Impedance: 40 Ω
- Sensitivity: 103 \pm 3dB
- Sampling Rate: 48kHz/24bit
- Peak Power: 38mW
- Rated Power: 30mW
- Signal-to-Noise Ratio: 85dB (A-Weighted)
- Total Harmonic Distortion: THD<0.5% at 1kHz
- Transmission Distance (open area): 15m
- Connector Type: 3.5mm TRS plug

Note: The above data are measured by Takstar laboratory which has the final interpretation right!

Charging time and battery life may vary depending on usage conditions.

Transmission range may vary due to obstacle, magnetic field, static, etc.

■ Function Descriptions

Transmitter

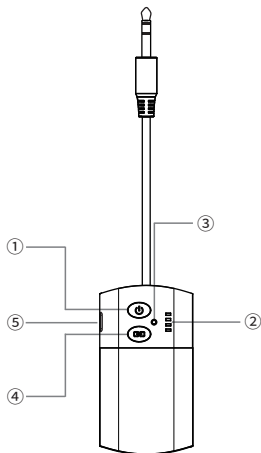

- ① Power Button: Press and hold this button for 2 seconds to power on or power off. When powered on, it automatically enters the reconnection state.
- ② Power Indicator: Consists of 4 bars, each representing 25% battery level. Blinks green when only one bar is left, indicating low battery and requires charging timely. Lights up gradually bar by bar while charging, and stays fully lit when fully charged.
- ③ Pairing Indicator: Blinks rapidly in green while pairing and stays lit once pairing completes.
- ④ Pairing Button: When powered on, press and hold this button for 5 seconds to manually enter pairing mode.
- ⑤ Type-C Charging Port: Connect to a charger with an output of 5V/500mA or higher using a Type-C charging cable.

Wireless Headphones

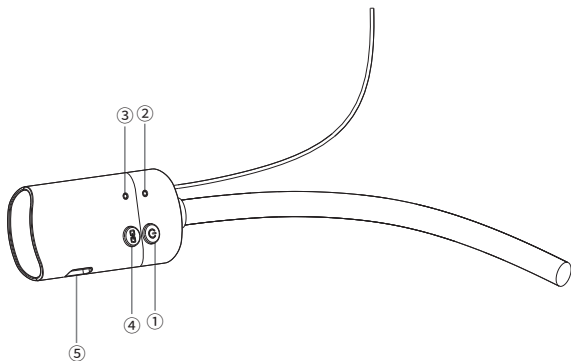

- ① Power Button: Press and hold this button for 2 seconds to power on or power off. When powered on, it automatically enters the reconnection state.
- ② Power Indicator: Lights up green while charging and turns off when fully charged.
- ③ Pairing Indicator: Blinks rapidly while pairing and stays lit once pairing completes.
- ④ Pairing Button: When powered on, press and hold this button for 5 seconds to manually enter pairing mode.
- ⑤ Type-C Charging Port: Connect to a charger with an output of 5V/500mA or higher using a Type-C charging cable.

■ Operation Instructions

Pairing Steps

The transmitter and headphones are pre-paired by default at the factory and will automatically connect when powered on. If you need to re-pair or pair additional wireless headphones, please follow the steps below:

1. Transmitter: When powered on, press and hold the pairing button on the transmitter for 5 seconds to enter pairing mode. Its pairing indicator will blink rapidly.
2. Wireless Headphones: When powered on, press and hold the pairing button on the receiver headphones for 5 seconds to enter pairing mode. Its pairing indicator will blink rapidly.
3. Pairing is successful if the pairing indicators on both the transmitter and wireless headphones become solidly lit.
4. To pair and connect multiple wireless headphones, repeat the above steps to enable the multi-link (one-to-many) function.

Note: When pairing multiple sets of devices, please avoid having multiple transmitters enter pairing mode simultaneously. Pair each transmitter separately.

Monitoring Connection

1. After successful pairing between the transmitter and wireless headphones, connect the transmitter to the $\varnothing 3.5\text{mm}$ headphone monitoring output of your audio interface.

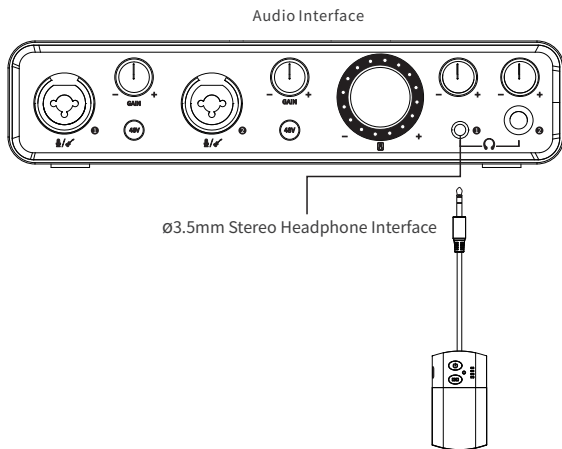

2. If the monitoring output of your audio interface is of $\varnothing 6.35\text{mm}$ standard, please use a $\varnothing 3.5\text{mm}$ to $\varnothing 6.35\text{mm}$ adapter in between (Adapter not included).

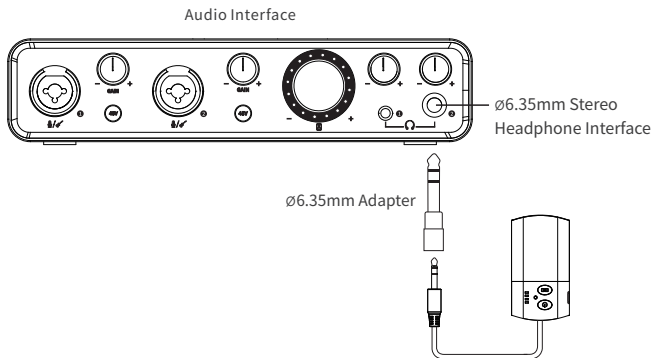

■ Correct Operation

For safe and comfortable operation, please read carefully and abide by the following items:

1. To avoid hearing loss, set the volume of the player to minimum before connecting the headset. After putting the earphone on, increase the volume to a proper level. Noise is measured in decibels (dB). Any outside noise of 85 decibels or more will cause gradual hearing loss.
2. Please pay attention to your operation habits! Volume and duration are proportional to hearing loss. The higher the volume, the shorter the time you should listen; the more comfortable the volume is, the longer you can listen. Listening at high volume for long will cause damage to your hearing.

This dB level chart compares some common noise sources and their potential danger to your hearing:





Sound Source	Noise Level	Consequence on Hearing
Whisper	30dB	Very quiet
Quiet office	50-60dB	Comfortable hearing level is below 60dB
Vacuum cleaner/ hair dryer	70dB	Somewhat invasive and may interfere with phone calls
Food processor	85-90dB	85dB (continuously 8 hours) will begin to hurt hearing
Garbage cleaning machine/ cement mixer	100dB	Exposure to sound of 90-100dB is suggested to be within 15 minutes if without protection
Electric saw/ electric drill	110dB	Frequent exposure to over 100dB for more than 1 minute can impair hearing
Rock concert (subjective)	110-140dB	Painful hearing starts at about 120dB

■ Maintenance



1. Please keep it in a dry and clean environment. During operation, prevent damage from water ingress, drop or collision.
2. Operating the headset in high temperature or high humidity for long can lead to device damage or shortened service life.
3. Keep the headset away from strong magnet to avoid demagnetizing and decreased sensitivity and performance.
4. Do not use strong chemical or detergent for cleaning.
5. Do not scratch the product surface with sharp objects.
6. Store in a clean, dry area if not used for a long period. Keep and use away from areas of high temperature and humidity.

■ Cautions

DANGER

To ensure your personal safety, do not wear or place the headset too close to the pacemaker (less than 10cm).	 Prohibited
Do not insert the cable plug into live power socket.	 Prohibited
For your safety and the safety of other traffic participants, do not use the headset while driving a vehicle, riding a bicycle or walking on the road.	 Follow
Keep away from fire to avoid explosion.	 Prohibited

WARNING

Not a toy. Children should not use without adult supervision.	 Follow
Abide by relative safety rules during operation. Do not use it if prohibited by laws and regulations to avoid accident.	 Follow

■ Safety Instructions

To avoid electric shock, overheat, fire, radiation, explosion, mechanical risk and injury or property loss due to improper use, please read and observe the following items before use:

1. Please check if the power of the connected equipment matches with that of this product before operation. Adjust the volume to proper level during operation. Do not operate at over-power or high-volume level for extended time to avoid product malfunction or hearing impairment.
2. If there is any abnormality during use (e.g., smoke, strange odor), please kill the power switch and unplug from power source, then send the product to the local dealer for repair.
3. Keep this product and its accessories in a dry and ventilated area. Do not store in a humid or dusty area for extended time. Keep away from fire, rain, liquid intrusion, bumping, throwing, vibrating, or from blocking any ventilation openings, to prevent malfunction.
4. Use the headphones within the recommended temperature range. Excessively high or low temperature may cause device malfunctions.
5. Please abide by safety rules during operation. Do not use the product in places prohibited by laws or regulations to avoid accident.
6. Do not disassemble or repair the product by yourself to avoid injury. If you have any questions or require any services, please contact our local dealer.

■ Label Meanings



This symbol indicates that this product should not be disposed of with your household waste, according to the WEEE directive (2012/19/EU) and your national law. This product should be

handed over to an authorized collection site for recycling waste electrical and electronic equipment (WEEE). Improper handling of this type of waste could have a possible negative impact on the environment and human health due to potentially hazardous substances that are generally associated with WEEE. At the same time, your cooperation in the correct disposal of this product will contribute to the effective usage of natural resources. For more information about where you can drop off your waste equipment for recycling, please contact your local city office, waste authority, or your household waste disposal service.

■ About This Manual

This manual contains up-to-date technical specifications as of printing. However, specifications contained herein may not conform to your particular product since Takstar is constantly improving its products. Also, specifications, devices or accessories available may vary from region to region. If you have any questions, please contact our local sales outlet. For the latest version/more information, please visit our website:

<https://www.takstar.com/>

Copyright ©2023 TAKSTAR. TAKSTAR, 得胜 and their respective logos are registered trademarks or trademarks of Guangdong Takstar Electronic Co., Ltd. in the PRC, and/or other countries. All other trademarks are the property of their respective owners.

产品服务保证书

姓名：_____ 电话：_____ 地址：_____

商品：_____ 型号：_____ 购买日期：_____ 年 ___ 月 ___ 日

维修记录栏 (由维修员填写)	维修员签名	日期

注意事项：

1. 本单为保修凭证，请用户妥善保管，如有遗失，恕不保修或退换。
2. 保修期限制：购买之日起十二个月内。
3. 除了不可抗力事件损坏外，由本公司负责，免费维修。
4. 如属保管不善或使用不当造成的损坏，维修点将酌情收费。
5. 擅自拆卸维修者，不予保修。
6. 以上保修条款仅限于中国市场适用（不含港澳台地区）。

◆广东得胜电子有限公司 ◆电话：400-6828-333 ◆地址：广东省惠州市博罗县龙溪街道富康一路2号



扫一扫，了解更多产品
Scan for more
product information

广东省电声工程技术研究开发中心 广东得胜电子有限公司制造

地址：广东省惠州市博罗县龙溪街道富康一路2号

服务热线：400 6828 333 传真：0752 6383950

邮箱：xs@takstar.com

网址：www.takstar.com

Guangdong Takstar Electronic Co., Ltd.

Address: No. 2 Fu Kang Yi Rd., Longxi Boluo

Huizhou, Guangdong 516121 China

Tel: 86 752 6383644 Fax: 86 752 6383952

Email: sales@takstar.com

Website: www.takstar.com