

TAKSTAR® 得胜

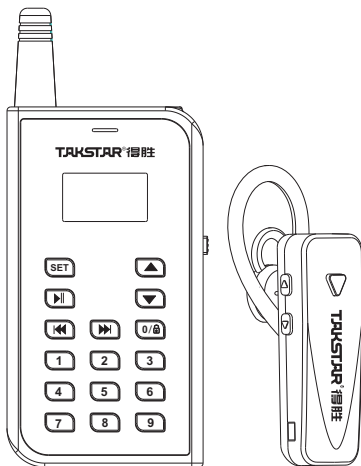

WTG-700 双讲 DUAL-TX 无线导览系统 Tour Guide System

使用手册 | User Manual

■ 前言

尊敬的用户：

感谢您选购得胜WTG-700（双讲）无线导览系统，为了您能够更好的了解使用本产品，建议您在使用前仔细阅读本说明书。

若存在有疑问或者您有宝贵的建议，可通过拨打得胜官方服务热线400 6828 333或微信扫描二维码关注得胜官方公众号与我们联系。



■ 产品特性

- UHF频率控制技术，信号稳定不串频，空旷无障碍使用距离可达200米；
- 发射器支持单讲/双讲模式切换，可根据使用场景灵活调整，满足使用需求；
- 可分离式麦克风设计，灵敏度高，拾音精准，音质干净清晰；
- 具备65个可调频道，能够实现同一个环境下多套发射器使用互不干扰；
- 支持一键对频，接收器只需开机，发射器一键对频所有接收器；
- 支持一键关机，发射器可以一键关掉所有正在连接的接收器；
- 低功耗设计，节能耐用，接收器续航约8小时，发射器续航约10小时；
- 可集中充电，亦可独立充电，支持选配充电箱，方便收纳管理，并具备消毒杀菌功能；
- 耳挂接收机仅重约18g，不限耳型双耳可戴，带来轻盈舒适佩戴体验；
- 发射器采用紧凑轻巧机身设计，功能全面，操作简易，携带更方便。

■ 适用范围

旅游观光、宗教活动、同声传译、接待考察、大型会议、教学讲课、工业生产等场合

■ 产品配置

WTG-700(套装)

发射器主机 (双讲)	(选配)
耳挂接收机	(选配)
充电箱	(选配)
头戴麦克风 (HM-700)	(选配)
说明书	1份

■ 技术参数

发射器主机 (双讲)

- 频率响应: 20Hz-16KHz
- 频率范围: UHF
- 发射功率: 18dBm
- 工作电流: 140mA
- 信噪比: 70dB
- 输出/输入接口: 3.5mm
- 电池容量: 2000mAh
- 充电电流: 400mA
- 机器尺寸: 93*52*16mm
- 单机重量: 约83g
- 充电指示: Led显示
- 工作时长: 10小时 (左右)
- 天线: 外置天线
- 有效距离: 200米
(不同场景和环境会有差异)

耳挂接收机

- 频率响应: 20Hz-16KHz
- 频率范围: UHF
- 工作电流: 45mA
- 信噪比: 70dB
- 输出/输入接口: 内置扬声器
- 电池容量: 300mAh
- 充电电流: 260mA
- 机器尺寸: 61*22.5*11.3mm
- 单机重量: 约18g
- 充电指示: 指示灯
- 工作时长: 8小时 (左右)
- 天线: 内置天线
- 有效距离: 200米
(不同场景和环境会有差异)

充电箱

- 充电位数：
54位（耳挂接收）+2位（发射主机）
- 交流输入：110-220V/AC
- 直流输出：5V/DC
- 产品尺寸：56*13*37CM
- 产品净重：约5.2Kg
- 产品毛重：约6.2Kg
- Uv杀毒：支持
- 其他功能：存储及充电

注：以上数据由得胜实验室测试得到，并拥有最终解释权！

■ 功能示意

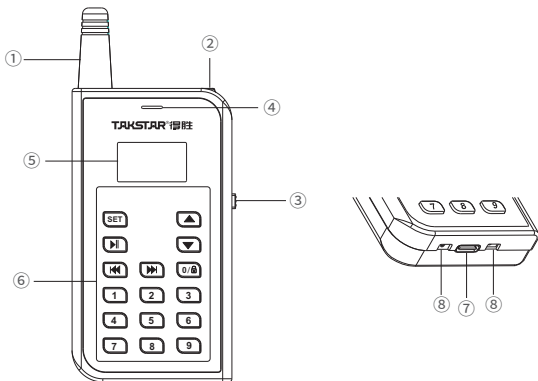

发射器主机 (双讲)

- ①外置天线：提升信号强度；
- ②麦克风接口：用于连接Φ3.5mm接口的麦克风；
- ③电源开关：拨至“ON”处为开启电源，拨至“OFF”处为关闭电源；
(注：发射器关机后不能立马开机，需等待指示灯熄灭后方可开机)
- ④指示灯：开机后，指示灯显示绿灯，表示进入正常工作状态；当指示灯显示红灯时，表示电量不足，应及时充电；
- ⑤显示屏：显示发射器当前语言、音量、频道等工作状态；
- ⑥功能按键区：用于音量调节、一键对频、一键关机、MP3播放设置等操作；
- ⑦Type-C充电接口：通过Type-C数据线的为发射器供电；
- ⑧充电触点：用于放置在充电箱中给发射器充电。

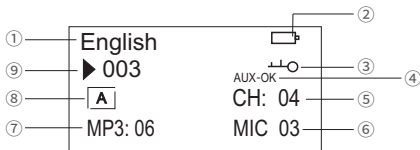

- ①语言显示
- ②电池电量显示
- ③锁定符号显示
- ④主讲收到副讲信号指示
- ⑤当前模式和频道显示
- ⑥麦克风音量显示
- ⑦MP3音量显示
- ⑧播放模式
- ⑨当前播放曲目显示

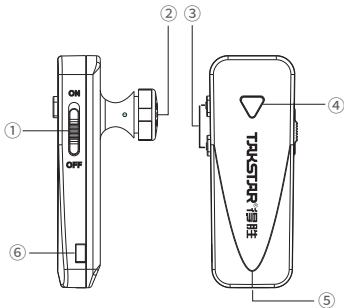

耳挂接收机

- ①电源开关：“ON”表示电源处于开启状态，“OFF”表示电源处于关闭状态。
- ②喇叭听筒：用于将声音信号传递于人耳。
- ③音量调节按键：开机状态下，按“▲”键增加音量，按“▼”减小音量。
- ④指示灯：开机状态下，指示灯显示绿灯，表示进入正常工作状态；当指示灯红灯闪烁时，为低电量状态，请及时充电；
- ⑤Type-C充电接口：通过Type-C数据线为耳挂接收机供电；
- ⑥充电触点：用于放置在充电箱中给接收器充电。

■ 使用说明

一、解锁设置

按住0键并打开发射器电源开关，此时显示屏“”符号消失，表示解锁成功。

二、频道调节

解锁后，通过点按“▲”键或“▼”键调节至所需频道。

三、一键对频所有接收机

打开接收机电源开关，发射器解锁后，点按“▲”键或“▼”键调节至所需频道，此时发射器指示灯常亮绿色，待绿色指示灯熄灭，且显示屏重新出现“”符号时，表示对频成功。

四、一键关闭所有接收机

按住“▲”键并将发射器开机，此时显示屏上出现“Off All Ear”提示，同时指示灯常亮绿灯，即完成一键关闭所有接收机。

五、单/双讲模式切换



按住  键并开机切换讲解模式，MCH为主讲模式，SCH为副讲模式；CH为独立讲解模式，独立讲解时建议调至CH模式，此模式下功耗较低，能延长使用时间。双讲模式下副讲必须与主讲同时使用（双讲模式下副讲不能单独使用），副讲连接成功后，主讲显示屏则会显示“AUX-OK”。

六、MP3相关功能操作



1) MP3功能开启/关闭

按住 8 键并开机，即可开启或关闭此功能。

2) MP3播放设置

正常开机状态下，按下播放键  即可正常播放，再按下此按键可暂停播放。如需选择上一曲或者下一曲，则点按  或  即可，显示屏上会出现当前播放曲目序号显示。如需输入指定曲目播放，则需在暂停播放状态下，输入所需的曲目序号即可。（注：要输入三位数字）

3) MP3播放模式设置

在播放状态下，按“SET”键可进行单曲循环、全部循环模式设置。当显示屏出现“”，表示当前曲目进行单曲循环播放；当显示屏出现“”，表示该文件夹所有曲目循环播放。无显示符号则表示当前曲目播放完即停止播放。

4) MP3音量调节

无需进行解锁,在播放状态下,点按“▲”键或“▼”即可调节MP3音量大小,共有15级音量可供选择。

七、MIC音量调节

无需进行解锁,在暂停播放MP3状态下,点按“▲”键或“▼”即可调节MIC音量大小,共有7级音量可供选择。

八、语言切换

在正常工作状态下,长按“SET”键,即可进行语言切换操作。

九、拷贝方式:

1. 发射器关机状态下,将Type-C数据线一端插入发射器的Type-C接口上,另一端连接至电脑的USB接口。
2. 电脑驱动安装成功后自动弹出移动磁盘窗口,即可进行音频拷贝。
3. 文件夹(语言) ---文件夹名必须为五位以上的大写字母组成,如CHINESE、ENGLISH等,支持以下语言文件夹的建立:

中文 CHINESE	英文 ENGLISH	法语 FRENCH	俄语 RUSSIAN	德语 GERMAN	日语 JAPANESE	韩语 KOREAN	意大利语 ITALIAN
---------------	---------------	--------------	---------------	--------------	----------------	--------------	-----------------

4. ID文件(曲目) ---文件名必须第1位为大写字母,并且与所在语言文件夹的第1位字母一致,后面为3位数的阿拉伯数字,如C001、E002等。

■ 安全警示

为避免电击、高温、着火、辐射、爆炸、机械危险以及使用不当等可能造成的人身伤害或财产损失，使用本产品前，请仔细阅读并遵守以下事项：

1. 使用产品时请确认所连接设备与本产品功率是否匹配以及合理调整设备音量大小，不要在超过产品功率及大音量下长时间使用，以免造成产品异常；
2. 使用中若发现有异常（如冒烟、异味等），请立即关闭电源开关并拔掉电源插头，然后将产品送经销商检修；
3. 本产品及配件都应放置在室内干燥通风处，勿长期存放在潮湿、灰尘多的环境，使用中避免靠近火源，雨淋、进水、过度碰撞、抛掷、振动本机及覆盖通风孔，避免损坏其功能；
4. 使用该产品时需遵守相关安全规定，法律法规明确禁止使用场合请勿使用产品，以免导致意外事故；
5. 请不要自行拆机改装或维修，以防止出现人身伤害，如有问题或服务需求请联系当地经销商跟进处理。

■ 关于本说明书

本说明书中内容符合截止印刷之日的技术规格。由于得胜公司会不断改进产品，本说明书可能不符合您的特定产品的技术规格。要获取最新版说明书，请访问得胜官网，然后下载说明书文件。技术规格、设备或另售的附件在各个地区可能有所不同，如有问题请与当地得胜经销商确认。如需更多支持和深层产品信息，请浏览得胜官方网站：<https://www.takstar.com/>

■ Preface

Dear Customer,

Thank you for purchasing Takstar WTG-700 (DUAL-TX) Tour Guide System. In order to correctly use the device, please read the manual carefully.

If you have any questions or suggestions, please contact our local dealer.

■ Features

- UHF technology, stable without crosstalk, use up to 200m in open areas.
- Switch between single-transmitter and dual-transmitter to adapt to various scenarios.
- High-sensitivity detachable mic picks up clear audio accurately.
- With 65 adjustable channels, able to use multiple sets of transmitters together without interference.
- Support one-key pairing which can sync all receivers to the transmitter easily.
- Support one-key poweroff which allows the transmitter to shut down all connected receivers immediately.
- Low-consumption design gives you 8h battery life on receiver and 10h on transmitter.
- Optional charging case to help you store and charge multiple devices simultaneously, with additional disinfection function.
- Ear-hook receiver weighs only about 18g, and can be worn on either ear with comfort.
- Transmitter is compact, lightweight, full-featured, easy to operate and carry.

■ Applications

Tourism, religious activities, simultaneous interpretation, reception visits, large conferences, lectures, industrial production, etc.

■ Package Contents

WTG-700 (Set)

Transmitter (DUAL-TX).....	Optional
Earhook Receiver	Optional
Charging Case	Optional
Headset Microphone (HM-700).....	Optional
User Manual.....	1 PC.

■ Specifications

Transmitter (DUAL-TX)

- Frequency Response: 20Hz-16KHz
- Frequency Range: UHF
- Transmission Power: 18dBm
- Working Current: 140mAh
- S/N Ratio: 70dB
- Output/Input Interface: 3.5mm
- Battery Capacity: 2000mAh
- Charging Current: 400mAh
- Dimensions: 93*52*16mm
- Weight: about 83g
- Charging Indication: LED display
- Battery Life: 10 hours (about)
- Antenna: external antenna
- Effective Distance: 200 meters
(may vary in different scenarios and environments)

Earhook Receiver

- Frequency Response: 20Hz-16KHz
- Frequency Range: UHF
- Working Current: 45mAh
- S/N Ratio: 70dB
- Output/Input Interface: built-in speaker
- Battery Capacity: 300mAh
- Charging Current: 260mAh
- Dimensions: 61*22.5*11.3mm
- Weight: about 18g
- Charging Indication: indicator light
- Battery Life: 8 hours (about)
- Antenna: built-in antenna
- Effective Distance: 200 meters
(may vary in different scenarios and environments)

Charging Case

- Charging Slots:
54 (earhook receivers) + 2 (transmitters)
- AC Input: 110-220V/AC
- DC Output: 5V/DC
- Dimensions: 56*13*37cm
- Net Weight: about 5.2Kg
- Gross Weight: about 6.2Kg
- UV Sterilization: supported
- Other Functions: storage and charging

Note: The above data are measured by Takstar laboratory, and Takstar has the final interpretation right!

■ Function Descriptions

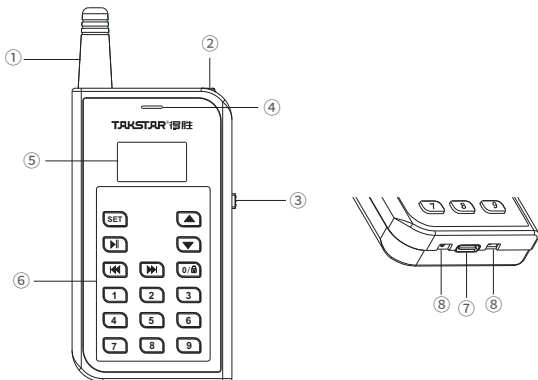

Transmitter (DUAL-TX)

- ① External Antenna: for improving signal strength.
- ② Mic Interface: for connecting to a mic with ø3.5mm interface.
- ③ Power Switch: turn to ON to power up, and OFF to power off.
(Note: DO NOT power up the transmitter immediately after it is powered off. Wait until the LED indicator goes off before restarting.)
- ④ LED Indicator: the indicator illuminates green when powered up and running normally, and changes to red when low power and requires charging in time.
- ⑤ Display Screen: display transmitter working status such as the current language, volume and channel.
- ⑥ Function Key Area: used for volume adjustment, one-key pairing, one-key poweroff, MP3 playback settings, etc.
- ⑦ Type-C Charging Port: supply power to the transmitter via a Type-C data cable.
- ⑧ Charging Contacts: for charging the transmitter when placed in the charging case.

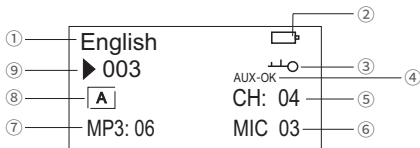

- | | |
|----------------------------|---------------------------------|
| ① Language | ② Battery Level |
| ③ Lock Symbol | ④ Auxiliary TX Signal Indicator |
| ⑤ Operating Mode & Channel | ⑥ Mic Volume |
| ⑦ MP3 Volume | ⑧ Playback Mode |
| ⑨ Current Track | |

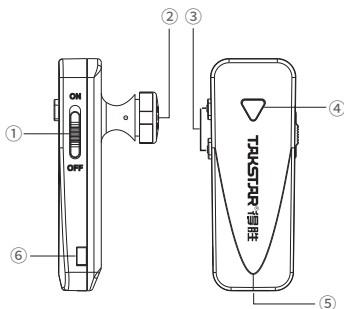

Earhook Receiver

- ① Power Switch: ON means the power is on, and OFF means the power is off.
- ② Speaker: used to transmit sound signals to the human ear.
- ③ Volume Control Buttons: when powered on, press ▲ button to increase the volume, or press ▼ to decrease.
- ④ LED Indicator: The indicator illuminates green when powered up and running normally, and changes to red when low power and requires charging in time.
- ⑤ Type-C Charging Port: supply power to the earhook receiver via a Type-C data cable.
- ⑥ Charging Contacts: for charging the receiver when placed in the charging case.

■ Operation Instructions

1. Unlock settings

Press and hold the 0 key and turn on the power switch of the transmitter, the  symbol on the display screen will disappear, indicating that it is unlocked.

2. Channel adjustment

After unlocking, adjust to the desired channel by pressing the ▲ or ▼ key.

3. Pair all receivers with one key

Turn on the power switch of the receiver, and after the transmitter is unlocked, press the ▲ or ▼ key to adjust to the desired channel, the indicator light of the transmitter will illuminate green. When the indicator light goes off and the  symbol reappears on the display screen, the pairing is successful.

4. Turn off all receivers with one key

To power off all receivers, press and hold the ▲ key and turn on the transmitter, the transmitter screen will prompt "Off All Ear", and its indicator will illuminate green.

5. Single/Dual-Transmitter mode switching



Press and hold  and power up the transmitter (TX) to switch between transmitter modes. CH mode is the recommended mode for single-TX application because it consumes less power. For dual-TX application, there are two modes, MCH (main channel) mode for TX #1, and SCH (side channel) mode for auxiliary TX #2. SCH mode must be used together with MCH mode. If SCH mode TX #2 is successfully connected, the screen on TX #1 will show the AUX-OK indicator.

6. MP3 related operation

a) Enable/Disable MP3 function

Press and hold key 8 and power up the transmitter to enable/disable MP3 function.

b) MP3 playback settings

When powered on normally, press the play button  to play, and then press this button again to pause. If you want to select the previous or next track, just press  or  , and the ID of the currently playing track will appear on the

WTG-700 (DUAL-TX) Tour Guide System

display. If you need to enter a specific track to play, you need to enter the required track ID when paused. (Note: Enter three digits)

c) MP3 playback mode setting

During MP3 playback, press the SET button to set single-cycle or all-cycle mode. When the display shows **[1]**, it means that the current track is being played in a single loop; when the display shows **[A]**, it means that all the tracks in this folder are played in a loop. If there is no display symbol, it means that it will stop playing after the current track finishes.

d) MP3 volume adjustment

No need to unlock. During MP3 playback, click the ▲ or ▼ button to adjust the MP3 volume. There are 15 levels of volume to choose from.

7. MIC volume adjustment

No need to unlock. When MP3 playback is paused, press the ▲ or ▼ button to adjust the volume of the mic. There are 7 levels of volume to choose from.

8. Language switching

When powered on, press and hold the SET button to switch languages.

9. Copy method:

1. When the transmitter is turned off, insert one end of the Type-C data cable into the Type-C interface of the transmitter, and connect the other end to the USB interface of the computer.
2. After the computer driver is successfully installed, the mobile disk window will pop up automatically, and you can start copying audio files.
3. Create a language folder (up to 8 supported) with one of the following uppercase names. Use any of the available names as substitute if your language is not included.

CHINESE	ENGLISH	FRENCH	RUSSIAN	GERMAN	JAPANESE	KOREAN	ITALIAN
---------	---------	--------	---------	--------	----------	--------	---------

4. ID file (track): Place audio tracks into the corresponding language folder.

Rename the audio files so that they start with an uppercase letter matching the folder's first letter, followed by a 3-digit Arabic ID number (e.g., C001, E002).

■ Safety Instructions

To avoid electric shock, overheat, fire, radiation, explosion, mechanical risk and injury or property loss due to improper use, please read and observe the following items before use:

1. Please check if the power of the connected equipment matches with that of this product before operation. Adjust the volume to proper level during operation. Do not operate at over-power or high-volume level for extended time to avoid product malfunction or hearing impairment.
2. If there is any abnormality during use (e.g., smoke, strange odor), please kill the power switch and unplug from power source, then send the product to the local dealer for repair.
3. Keep this product and its accessories in a dry and ventilated area. Do not store in a humid or dusty area for extended time. Keep away from fire, rain, liquid intrusion, bumping, throwing, vibrating, or from blocking any ventilation openings, to prevent malfunction.
4. Please abide by safety rules during operation. Do not use the product in places prohibited by laws or regulations to avoid accident.
5. Do not disassemble or repair the product by yourself to avoid injury. If you have any questions or require any services, please contact our local dealer.

■ About This Manual

This manual contains up-to-date technical specifications as of printing. However, specifications contained herein may not conform to your particular product since Takstar is constantly improving its products.

Also, specifications, devices or accessories available may vary from region to region. If you have any questions, please contact our local dealer. For the latest version/more information, please visit our website:

<https://www.takstar.com/>

注意事项:

1. 本单为保修凭证, 请用户妥善保管, 如有遗失, 恕不保修或退换。
2. 保修期限制: 购买之日起十二个月内。
3. 除了不可抗力事件损坏外, 由本公司负责, 免费维修。
4. 如属保管不善或使用不当造成的损坏, 维修点将酌情收费。
5. 擅自拆卸维修者, 不予保修。
6. 以上保修条款仅限于中国市场适用 (不包含港澳台地区)。

产品服务保证书

姓名: _____ 电话: _____ 地址: _____

商品: _____ 型号: _____ 购买日期: _____ 年 _____ 月 _____ 日

维修记录栏 (由维修员填写)	维修员签名	日期

◆广东得胜电子有限公司 ◆电话: 400-6828-333 ◆地址: 广东省惠州市博罗县龙溪街道富康一路2号



扫一扫，了解更多产品
Scan for more
product information

广东省电声工程技术研究开发中心 广东得胜电子有限公司制造

地址：广东省惠州市博罗县龙溪街道富康一路2号

服务热线：400 6828 333 传真：0752 6383950

邮箱：xs@takstar.com

网址：www.takstar.com

Guangdong Takstar Electronic Co., Ltd.

Address: No. 2 Fu Kang Yi Rd., Longxi Boluo

Huizhou, Guangdong 516121 China

Tel: 86 752 6383644 Fax: 86 752 6383952

Email: sales@takstar.com

Website: www.takstar.com