

TAKSTAR® 得胜



M-2F 系列 | 无线麦克风
SERIES | Wireless Microphone

尊敬的用户：

感谢您选购得胜M-2F系列无线麦克风，为了您能够更好的了解使用本产品，建议您在使用前仔细阅读本说明书。

若存在有疑问或者您有宝贵的建议，可通过拨打得胜官方服务热线4006828333或微信扫描二维码关注得胜官方公众号与我们联系。



■ 产品特性

- 采用UHF频段设计，真分集自动接收技术，抗干扰性强
- 使用PLL锁相环和高精度石英晶体，加上微电脑单片机控制，频率稳定度高
- 支持多台叠机使用（自动或低功率模式），有效距离可达500米（高功率模式无遮挡）
- 红外对频功能，迅速完成发射机与接收机频率同步，使用方便快捷
- 具备数码导频功能，有效避免干扰和串频现象
- 自动选讯功能，可快速准确地找出无干扰的可用信道，大大简化安装中的调试工作
- 具备可调发射功率和可调静噪门限，二者配合可有效方便地控制使用距离
- 采用双升压电路设计，电池电压降低时不会影响发射的性能
- 特有AI智能接收调节功能，有高、低功率和自动三种工作状态，灵活调节信号强弱，有效控制干扰，增加使用稳定性
- 接收机显示屏上能实时反映发射器的射频、音频和电池电量等信息
- 高拾音灵敏度，出色的音质，使您的讲话或者唱歌都能轻松自如
- 金属机身，铝合金拉丝面板配合双LCD显示屏，美观大方、操作直观

■ 产品适用范围

- 适合户内外远距离扩声需求的学校、园区等专业扩声使用

■ 产品配置

M-2FH无线麦克风

接收主机	1台
手持麦克风	2支
音频连接线	1条
电源适配器	1条
UHF天线	4条
角码	2个
说明书	1份

M-2FP无线麦克风

接收主机	1台
腰包发射机	2个
耳挂麦克风	2个
领夹麦克风	2个
音频连接线	1条
电源适配器	1条
UHF天线	4条
角码	2个
说明书	1份

■ 技术参数

接收机参数

- 频率范围：612-667MHz (A通道：612.25~637, B通道：642.25~667)
- 可调信道数：200CH, 最大支持1050CH (可配置6个频段, 每个频段200信道, 925段为50信道250KHz)
- 振荡方式：锁相环PLL频率合成
- 频率稳定性：±10ppm
- 接收方式：超外差二次变频
- AI智能方式：L/H/Auto三档
- 接收灵敏度：-95~-75dBm可调
- 内置天线放大器：15~20dBm
- 音频频响：40-18000Hz
- 失真度：≤0.5%
- 信噪比：≥110dB
- 音频输出：+10dB (1路φ6.3混合输出, 2路卡侬座平衡输出)
- 电源规格：DC 12V/1A
- 消耗功率：≤7W

发射器参数

- 频率范围：612-667MHz
- 可调信道数：200CH，最大支持1050CH（可配置6个频段，每个频段200信道，925段为50信道250KHz）
- 振荡方式：锁相环PLL频率合成
- 频率稳定性：±10ppm
- 调制方式：FM调频
- 射频功率：20~50mw
- 音频频响：40-18000Hz
- 失真度：≤0.5%
- 电池规格：2x1.5V AA
- 续航时间：8-20小时（视电池容量而有所差异）

注：以上数据由得胜实验室测试得到，并拥有最终解释权！

■ 功能示意

接收主机正面板

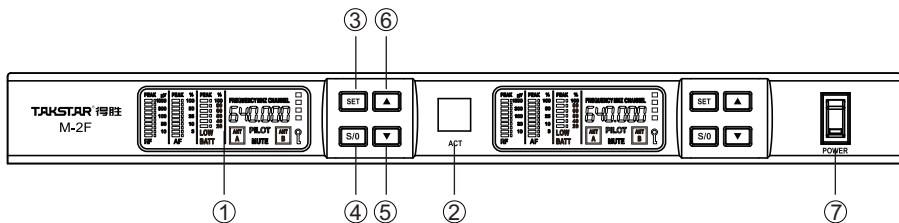

- ① 显示屏：显示频率信道、信号强度、电量状态、分集指示、智能指示导频、静音以及锁定指示等工作状态。
- ② 红外对频窗口：配合“SET”按键，将频率参数传至发射机，使接收机与发射机频率同步。
- ③ SET键：用于功能调整及切换。
- ④ S/O键：接收增益和音量调节。
- ⑤ “▼”键：用于调节频率、信道、自动搜台、对频、减小音量等功能。
- ⑥ “▲”键：用于调节频率、信道、对频、增大音量等功能。
- ⑦ 电源开关：用于控制机内电源供应。

接收主机正面板

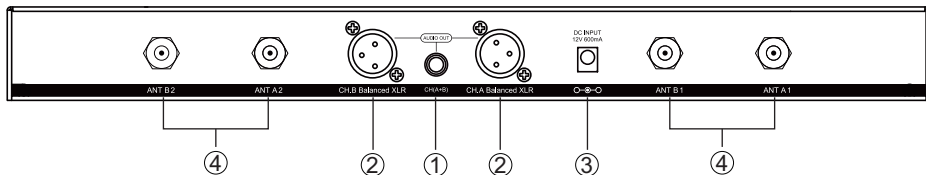

- ① 6.3混合音频输出接口：将两路音频信号混合成一路输出。
- ② 音频平衡输出接口：采用“XLR”型插座，提供各通道独立信号输出。
- ③ 电源插座：通过连接电源适配器进行供电。
- ④ 天线插口：用于连接外置天线。

LCD屏幕界面

- ① RF指示：显示RF信号接收强度。
- ② AF指示：显示AF信号动态。
- ③ 电池电量指示：显示发射机当前电池的电量状态。
- ④ 频率和通道指示：显示当前通道的频率或者通道，“FREQUENCY MHZ”字符为频率显示指示，指示出字符下方当前显示的为接收机频率，可切换到显示信道指示的“CHANNEL”字符。
- ⑤ 锁定指示：显示锁定的状态。
- ⑥ “ANT A”与“ANT B”为当前接收天线指示；显示屏上分集指示会显示当前是选择的A接收通路还是B接收通路。当麦克风移动时，该指示会根据信号情况在A、B之间切换，显示“ANT A”或“ANT B”指示。
- ⑦ “PILOT”字符为数码ID导频状态指示，当“PILOT”长亮时数码导频为开启状态，当“PILOT”不亮时音码导频为关闭状态；正常使用时数码导频一定要开启；
- ⑧ “MUTE”字符为静音指示，用于表明接收机在接收状态，但未接收到合法信号时，该指示点亮，接收机内部关闭音频输出；收到合法信号后，接收机内部开启音频输出，同时该指示熄灭；以下三种情况会出现静音指示：
 - I. 没有射频信号时。
 - II. 接收机开启了数码导频，但麦克风未开启，此时需要重新对频。
 - III. 对接收机进行任何按键操作时。

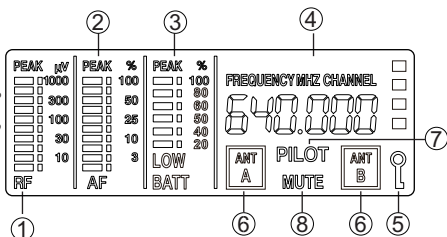

手持发射器

- ① 电源开关：点开开启麦克风电源，长按关闭麦克风电源。
- ② 红外对频窗口：配合接收机对频键，将频道参数传至发射器。
- ③ LCD显示屏：显示当前工作频道和电池电量。
- ④ 电池仓：用于安装2节AA电池。（注意电池放置极性）
- ⑤ 天线：使用时注意不要遮挡天线，以免影响使用距离。

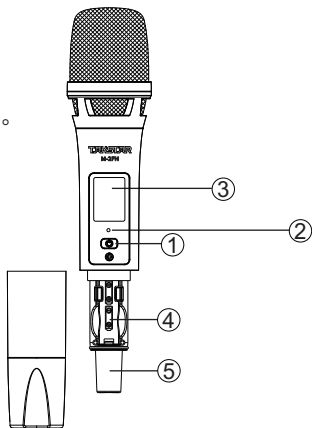

腰包发射器

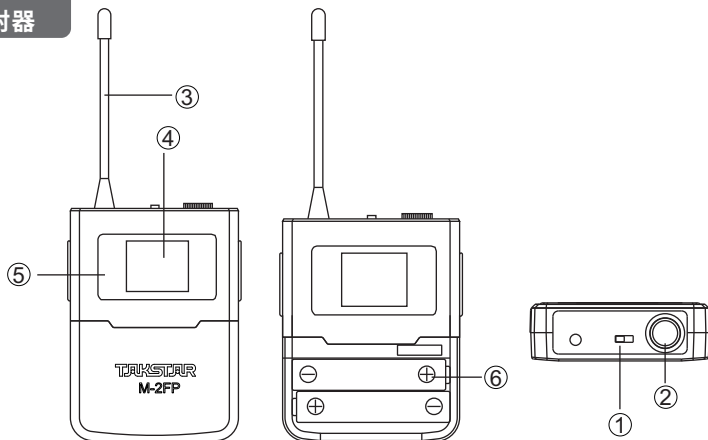

- ① 电源开关：拨至“ON”位置为开起电源，拨至“OFF”位置为关闭电源。
- ② 麦克风输入插座：用来连接领夹或者头戴式麦克风。
- ③ 发射天线：1/4波长鞭状发射天线。
- ④ LCD显示屏：显示当前工作频道和电池电量。
- ⑤ 红外对频窗口：配合接收机对频键，将频道参数传至发射器。
- ⑥ 电池仓：用于安装2节AA电池。（注意电池放置极性）

■ 使用说明

一、频率、信道调节与显示状态切换

1. 频率、信道显示状态切换

正常开机时系统默认为显示频率状态，短按"SET"键可进入显示频率、信道切换操作，屏幕上的"FREQUENCY MHZ"字符开始闪烁，此时显示频率；再短按"SET"键，屏幕上的"CHANNEL"字符开始闪烁，此时显示信道。设定好后3秒后自动保存退出。

2. 频率调节

正常开机并在显示频率数字的状态下，短按"SET"键可进入手动频率调节功能，此时屏幕对应的频率数字开始闪烁，短按或长按"▲"、"▼"按键可进行频率调节，待调到所需要的频率值。设定好后3秒后自动保存退出。

3. 信道调节

正常开机并在显示信道的状态下，短按"SET"键一次可进入手动信道号调节功能，屏幕对应的信道号"CH-XXX"（XXX为000-099范围）字符开始闪烁，短按或长按"▲"、"▼"按键可进行信道调节，待调节到所需要的信道值。设定好后3秒后自动保存退出。

二、AI智能调节

正常开机状态下，短按S/O键可进入AI智能切换调节，共有L/H/Auto三挡模式调节。

- ①：L挡：此挡为低挡，接收信号能力稍较弱，但抗干扰较强。用于距离不须要太远，多台叠机使用。
- ②：H挡：此挡为高挡，接收信号能力很强，用于远距离使用。
- ③：Auto挡：AI自动挡，当发射麦克风离接收机较近时，系统会自动调节到L低挡；当发射麦克风离接收机较远时，系统会自动调节到H高挡，以达到自动智能调节。

三、红外对频操作

正常开机状态下，长按"▲"键可进入红外对频功能，具体操作如下：

- ① 打开需要同步的麦克风（手持或腰包）电源开关；
- ② 将发射机的红外对频窗口与接收机红外对频窗口呈直线相对，并把麦克风与接收机的对频距离控制在1米以内；
- ③ 长按"▲"键（A、B分别对应左、右通道），相对应通道上的屏幕上将显示"55--"（见下图），几秒后屏幕上的"00--"消失；此时，发射麦克风上的频率与接收机上的频率显示相同，则表示对频成功。

四、自动搜索空闲信道并对频

正常开机状态下，长按"▼"键可进入自动搜索空闲信道并对频功能：

- ① 打开需要同步的麦克风（手持或腰包）电源开关；
- ② 将发射机的红外对频窗口与接收机红外对频窗口呈直线相对，并把麦克风与接收机的对频距离控制在1米以内；
- ③ 长按"▼"键，屏幕显示"99-0XX"标志字符闪烁，从99到00是搜索信道数，后面的0XX是指相对信道的杂音信号的大小指示。系统会自动找到杂音信号比较小的地方。如搜到可用频段或信道系统将会自动保存，同时自动进入对频功能，屏幕会显示"55--"，几秒后屏幕上的"00--"消失，此时系统已经完成整个流程，系统自动保存并退出。
- ④ 在自动搜索空闲信道并对频功能执行过程中短按"▲"键则可随时取消此操作。

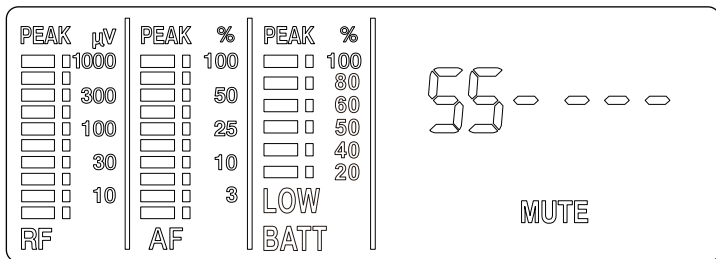

五、音量调节

长按S/O键3秒，进入音量调节状态，点按"▲"、"▼"键为加减音量调节，按SET键为确定键保存退出。

六、系统锁定/解锁操作

正常开机状态下，长按"SET"键2秒，即可锁定接收机，此时屏幕显"锁匙"字符，接收机处于锁定状态时所有功能按键不起作用；再长按"SET"键2秒可解锁，此时屏幕显的"锁匙"字符消隐，按键功能恢复。

七、系统菜单设置

按住"▲"键开机，可进入系统设置菜单，此时屏幕显示"-FSET-"，1秒后系统会自动跳转到闪烁的子菜单"SQL"；短按"SET"键可循环选择闪烁的子菜单"SQL"、"RFP"、"LED"、"ID"；在相对应的子菜单短按"▲"键或"▼"键可进行调节设定；在操作过程中再按"IR"键可保存并退出。

- ① "SQL"为接收灵敏度，每2dB一档，从-95dB到-75dB共11档，可短按"▲"键或"▼"键进行选择；设置SQ越高，在提高抗干扰能力的时候，同时缩短了发射器工作距离，要灵活调整。

- ② "RFP"为发射功率, "H"时, 对频后发射为高功率; "L"时, 对频后发射为低功率, 可短按"▲"键或"▼"键进行选择;
- ③ "LED"为LED背光熄灭时间, "ON"时, 对频后发射背光长亮; "OFF"时, 对频后发射背光延时熄灭, 可短按"▲"键或"▼"键进行选择;
- ④ "ID"为是否开启导频信号, "ON"时, 开启导频信号; "OFF"时, 关闭导频信号, 可短按"▲"键或"▼"键进行选择; 有导频时对应的"PILOT"字符正常显示, 无导频时对应的"PILOT"字符不显示。导频功能开机处于开启状态。

八、使用建议

1. 安置接收机

- ① 从包装箱中取出接收机后, 将4支接收天线连接到接收机的天线插口(ANT), 并调节2支天线为顶部向上并与地面基本垂直的方向。本接收机为真分集自动选讯的产品, 接收机具备4支接收天线, 并且内部具备4套完整的接收电路和分集控制电路, 每2支接收天线和2套接收电路负责1支麦克风信号的接收。对于每一支麦克风来说, 接收机的2支接收天线处在不同的位置, 所接收的麦克风信号会有明显差别, 分集控制电路会自动比较和选择使用信号较强的一路, 以消除接收时的盲区。
- ② 建议勿将接收机置于金属机柜中, 金属机柜会屏蔽射频信号, 影响接收距离。
- ③ 应该避免将接收机与影碟机、电脑、点歌机、音频处理器、LED大屏、大屏处理器、LED灯具和灯光控制处理设备放在一起, 它们发出的杂散干扰信号也会影响接收距离。
- ④ 接收机应尽量接近演出区, 并且与大的金属物、墙面、脚手架、天花板等物体至少保持1.5米的距离, 并尽量保证麦克风与接收机之间有空旷的信号直射途径。
- ④ 请在离开接收机3米以外使用麦克风, 使用过程中, 各麦克风之间尽量不要靠得太近, 保持30cm以上的间距。

2. 检查与接通电源

请先检查确认接收机的电源适配器规格与市电规格相符, 如不相符, 请停止安装与使用, 否则将可能损坏机器或导致危险。确认电压规格相符后, 将电源适配器的输出插头插入接收机背面的"DC INPUT"插孔, 并将适配器插入市电插座。

3. 工程安装调试方法

同区域多套使用时, 其安装调试方法如下:

- ① 先打开一台接收机电源开关, 麦克风都不开启, 观察接收机第一通道RF信号指示是否有信号, 如有信号, 表示有干扰信号, 则进行调节到没信号指示状态。
- ② 打开麦克风, 确保第一支麦克风在实际使用位置工作正常。
- ③ 第一只麦克风保持打开状态, 观察第二通道RF信号指示状态 (重复第一通道的操作确认没干扰信号)

④ 开启第二支麦克风，确保第二支麦克风在实际使用位置工作正常，之后一次类推，保证调试好的麦克风开启状态，重复第②③④步直到所有话筒调试完毕。

⑤ 按照以上步骤调试完成后，每次只关闭一支麦克风，查看对应通道的RF指示灯是否有信号显示，正常情况下为无信号显示，如果有信号显示则需要继续更换频率。将每个通道再检查一遍，以便达到使用要求。

注：如果有麦克风损坏或者丢失，需要补充，请用备品麦克风与接收机进行对频操作后即可使用。

■ 安全警示

为避免电击、高温、着火、辐射、爆炸、机械危险以及使用不当等可能造成的人身伤害或财产损失，使用本产品前，请仔细阅读并遵守以下事项：

1. 使用产品时请确认所连设备与本产品是否匹配以及合理调整音量大小，不要在超过产品功率及大音量下长时间使用，以免造成产品异常；
2. 使用中若发现有异常（如冒烟、异味等），请立即关闭电源开关并拔掉电源插头，然后将产品送售后服务网点检修；
3. 若产品需要使用可拆装电池时，严禁使用外壳绝缘材料破损的电池，请不要为非充电电池充电；
4. 废弃电池需放入指定的分类垃圾桶，不可作为儿童玩具或直接丢弃，以免造成安全隐患或影响环境；
5. 本产品及配件都应放置在室内干燥通风处，勿长期存放在潮湿、灰尘多的环境，使用中避免靠近裸露火源、碰到液体物质、雨淋、产品进水、过度碰撞、抛掷、振动本机及覆盖通风孔，以免损坏其功能；
6. 若产品需要固定于墙壁或天花板上时，请确保固定到位，防止因固定强度不足导致产品发生跌落危险；
7. 使用该产品时需遵守相关安全规定，法律法规明确禁止使用场合请勿使用本机，以免导致意外事故；
8. 请不要自行拆机改装或维修，以防止出现人身伤害，如有问题或服务需求请联系当地售后服务网点跟进处理。

■ 关于本说明书

本说明书中内容符合截止印刷之日的技术规格。由于得胜公司会不断改进产品，本说明书可能不符合您的特定产品的技术规格。要获取最新版说明书，请访问得胜官网，然后下载说明书文件。技术规格、设备或另售的附件在各个地区可能有所不同，如有问题请与当地得胜销售网点确认。如需更多支持和深层产品信息，请浏览得胜官方网站：<https://www.takstar.com>

M-2F SERIES Wireless Microphone

Dear Customer,

Thank you for purchasing Takstar M-2F Series Wireless Microphone. To better understand and use the product, please read this manual carefully. If you have any questions or suggestions, please contact our local dealer.

■ Features

- UHF true diversity system with strong anti-interference capability.
- PLL phase-locked loop, precision quartz crystal, and MCU control for high frequency stability.
- Able to use multiple receivers together under auto/low power modes; or up to 500m within line of sight under high power mode.
- Infrared frequency sync function for convenient and quick setup.
- Digital pilot signal function effectively prevents interference and crosstalk.
- Automatic channel scan finds interference-free usable channels quickly and easily.
- Adjustable transmission power and squelch threshold, adaptive to different use distance.
- Dual boost circuit design ensures unaffected transmission performance even with decreased battery voltage.
- Unique AI reception control, with adjustable high/low/auto power modes, for improved stability.
- Receiver display screen provides real-time info on transmitter RF, AF, and battery levels.
- Highly sensitive pickup, allowing effortless and natural speech or singing.
- Metal body, dual LCD screens, aluminum alloy casing, stylish and elegance.

■ Applications

- Pro sound amplification, especially in schools, campuses, and other indoor and outdoor venues requiring long-distance coverage.

M-2F SERIES Wireless Microphone

■ Package Contents

M-2FH Wireless Microphone

Receiver	1 PCS
Handheld Microphone	2 PCS
Audio Cable	1 PCS
Power Adapter	1 PCS
UHF Antenna	4 PCS
Angle Bracket	2 PCS
User Manual	1 PCS

M-2FP Wireless Microphone

Receiver	1 PCS
Bodypack Transmitter	2 PCS
Earhook Microphone	2 PCS
Lavalier Microphone	2 PCS
Audio Cable	1 PCS
Power Adapter	1 PCS
UHF Antenna	4 PCS
Angle Bracket	2 PCS
User Manual	1 PCS

■ Specifications

Receiver Specifications

- Frequency Range: 612-667MHz (Channel A: 612.25~637, Channel B: 642.25~667)
- Adjustable Channel Count: 200CH, max support for 1050CH (configurable in 6 frequency bands, each band with 200 channels, with 925Mhz band having 50 channels at 250KHz)
- Oscillation Method: Phase-locked loop (PLL) frequency synthesis
- Frequency Stability: $\pm 10\text{ppm}$
- Reception Method: Superheterodyne double conversion
- AI Intelligent Modes: L/H/Auto (Low, High, Auto)
- Reception Sensitivity: -95~-75dBm (adjustable)
- Built-in Antenna Amplifier: 15~20dBm

M-2F SERIES Wireless Microphone

- Audio Frequency Response: 40-18000Hz
- Distortion: $\leq 0.5\%$
- Signal-to-Noise Ratio: $\geq 110\text{dB}$
- Audio Output: +10dB (1 channel $\phi 6.3$ mixed output, 2 channels XLR balanced output)
- Power Requirements: DC 12V/1A
- Power Consumption: $\leq 7\text{W}$

Transmitter Specifications

- Frequency Range: 612-667MHz
- Adjustable Channel Count: 200CH, max support for 1050CH (configurable in 6 frequency bands, each band with 200 channels, with 925Mhz band having 50 channels at 250KHz)
- Oscillation Method: Phase-locked loop (PLL) frequency synthesis
- Frequency Stability: $\pm 10\text{ppm}$
- Modulation Method: FM modulation
- RF Power: 20~50mW
- Audio Frequency Response: 40-18000Hz
- Distortion: $\leq 0.5\%$
- Battery Specifications: $2 \times 1.5\text{V AA}$
- Battery Life: 8-20 hours (subject to battery capacity)

Note: The above data are measured by Takstar laboratory which has the final interpretation right!

■ Function Descriptions

Receiver Front Panel

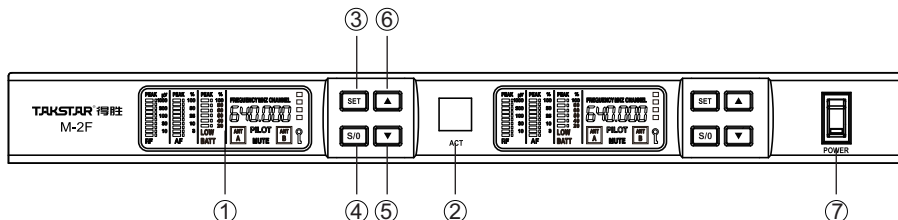

- ① Display Screen: Shows the working status, including frequency, channel, signal strength, battery level, diversity indicator, intelligent mode, pilot signal, mute, and lock status.
- ② Infrared Sync Window: Used in conjunction with the SET button to transmit frequency parameters to the transmitter, synchronizing the frequency between the receiver and transmitter.
- ③ SET Button: Used for function adjustment and switching.
- ④ S/O Button: Adjusts the reception gain and volume.
- ⑤ ▼ Button: Used for adjusting frequency, channel, auto-scan, frequency pairing, decreasing volume, and other functions.
- ⑥ ▲ Button: Used for adjusting frequency, channel, frequency pairing, increasing volume, and other functions.
- ⑦ Power Switch: Controls the internal power supply of the device.

Receiver Rear Panel

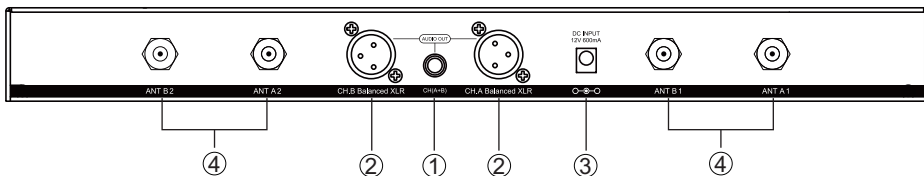

- ① 6.3mm Mixed Audio Output Interface: Combines two channels of audio signals into a single output.
- ② Balanced Audio Output Interface: Utilizes XLR-type sockets to provide independent signal outputs for each channel.
- ③ Power Socket: Used to connect the power adapter for power supply.
- ④ Antenna Socket: Used to connect external antennas.

M-2F SERIES Wireless Microphone

LCD Screen Interface

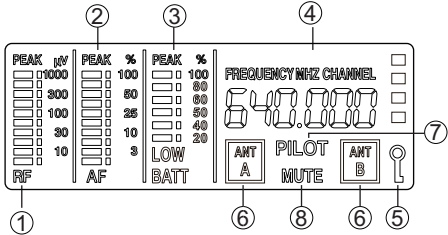
- 
- The diagram shows the LCD screen interface with seven numbered callouts: 1. RF Indicator (leftmost bar graph), 2. AF Indicator (second bar graph), 3. Battery Level Indicator (third bar graph), 4. Frequency and Channel Indicator (top right text area), 5. Lock Indicator (key icon), 6. ANT A and ANT B Indicators (two small boxes), 7. PILOT Status Indicator (small box), and 8. MUTE Indicator (small box). The screen displays 'PEAK' levels in dBV and %, 'RF', 'AF', and 'BATT' indicators, 'FREQUENCY MHZ CHANNEL', 'ANT A', 'PILOT MUTE', and 'ANT B'.
- ① RF Indicator: Displays the received RF signal strength.
 - ② AF Indicator: Displays the dynamic of the AF signal.
 - ③ Battery Level Indicator: Shows the current battery level of the transmitter.
 - ④ Frequency and Channel Indicator: Displays the frequency or channel of the current selection. The value beneath FREQUENCY MHZ indicates the receiver frequency. It can be switched to display the CHANNEL info.
 - ⑤ Lock Indicator: Shows the locked status.
 - ⑥ ANT A and ANT B Indicator: Shows which antenna is being used in the diversity system. When the mic moves, this indicator may switch between ANT A and ANT B based on the signal conditions.
 - ⑦ PILOT Status Indicator: Appears on screen when pilot signal is enabled; Disappears when pilot signal is disabled. Pilot signal should be enabled during normal use.
 - ⑧ MUTE Indicator: Shows whether the receiver is in receiving state. Appears if there is no valid signal received, in which case the audio output is muted. Disappears if there is valid signal received, which unmutes the audio output. The mute indicator appears in the following three situations:
 - 1) No RF signal is detected.
 - 2) Pilot signal enabled on the receiver, but mic is not turned on, which requires re-sync.
 - 3) Any key operation is performed on the receiver.

Handheld Transmitter

- ① Power Switch: Press to turn on the mic power, press and hold to turn it off.
- ② Infrared Sync Window: Used in conjunction with the SET key on the receiver to transmit channel parameters to the transmitter.
- ③ LCD Display: Shows the current working channel and battery level.
- ④ Battery Compartment: Used to install two AA batteries. (Pay attention to the battery polarity)
- ⑤ Antenna: Do not obstruct the antenna during use to avoid affecting the transmission distance

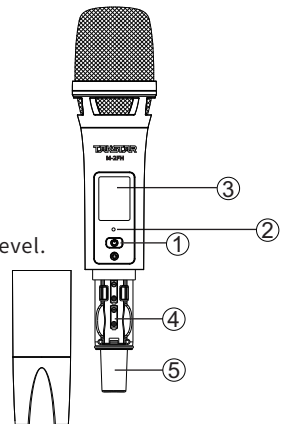

M-2F SERIES Wireless Microphone

Bodypack Transmitter

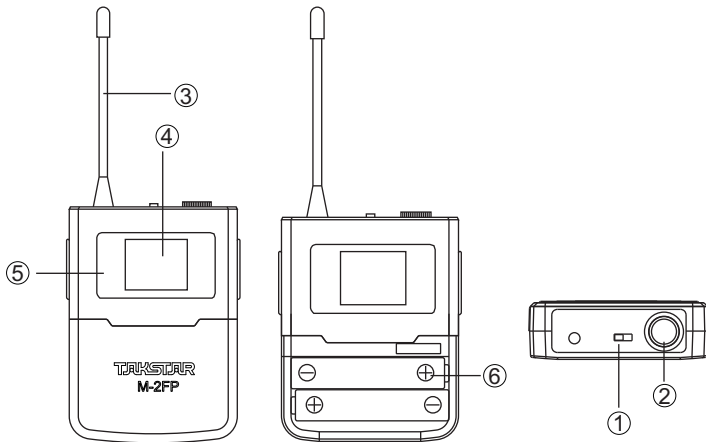

- ① Power Switch: Slide to the ON position to turn on the power, or to the OFF position to turn off the power.
- ② Mic Input Jack: Used to connect a lavalier or headset mic.
- ③ Transmission Antenna: Quarter-wave whip antenna for transmission.
- ④ LCD Display: Shows the current working channel and battery level.
- ⑤ Infrared Sync Window: Used in conjunction with the SET key on the receiver to transmit channel parameters to the transmitter.
- ⑥ Battery Compartment: Used to install two AA batteries. (Pay attention to the battery polarity)

■ Operating Instructions

I. Frequency/Channel Adjustment & Display Mode Switching

1. Frequency/Channel Display Mode Switching

By default, the system displays the frequency status when powered on. Press SET button briefly to switch between frequency and channel mode. On the screen, FREQUENCY MHZ flickers when it's in frequency mode. Press SET button again to switch to channel mode, in which case CHANNEL flickers. Once set, the system automatically saves and exits editing after 3 seconds.

2. Frequency Adjustment

When the system is powered on and displaying the frequency, press SET button briefly to enter manual frequency editing mode. The corresponding frequency digits on the screen start to flash. Press ▲ or ▼ buttons briefly or press and hold to adjust the frequency until the desired value is reached. Once set, the system automatically saves and exits editing after 3 seconds.

3. Channel Adjustment

When the system is powered on and displaying the channel, press SET button once to enter the manual channel editing mode. The corresponding channel number CH-XXX (XXX ranging from 000 to 099) on the screen starts to flash. Press ▲ or ▼ buttons briefly or press and hold to adjust the channel until the desired value is reached. Once set, the system automatically saves and exits editing after 3 seconds.

II. AI Intelligent Adjustment

When powered on, press S/O button briefly to switch between AI intelligent modes.

There are three modes available: L (Low), H (High), and Auto.

- ① L Mode: With slightly weaker signal reception but stronger interference resistance, suitable for short distances and when multiple receivers are used together.
- ② H Mode: With strong signal reception, suitable for long-distance use.
- ③ Auto Mode: AI automatic mode which switches to L mode when the mic transmitter is close to the receiver, and switches to H mode when the mic transmitter is far from the receiver.

III. Infrared Sync Operation

When powered on, press and hold ▲ button to enter infrared pairing mode. Follow the steps below:

- ① Turn on the power switch of the mic (handheld or bodypack).

M-2F SERIES Wireless Microphone

- ② Align the infrared window of the transmitter with the infrared window of the receiver in a straight line, and keep the distance between them within 1 meter.
- ③ Press and hold ▲ button (A side corresponds to left channel, and B side to right channel), the screen on the corresponding channel will display "55--" (refer to the figure below). After a few seconds, the "00--" on the screen will disappear. At this point, if the frequency displayed on the transmitter matches the frequency displayed on the receiver, it indicates successful pairing.

IV. Automatic Search for Free Channels and Pairing

When powered on, press and hold ▼ button to the automatic search for free channels and start pairing:

- ① Turn on the power switch of the mic (handheld or bodypack).
- ② Align the infrared window of the transmitter with the infrared window of the receiver in a straight line, and keep the distance between them within 1 meter.
- ③ Press and hold ▼ button, the screen will display a flickering "99-0XX" symbol, where 99 to 00 represents the number of channels being searched, and 0XX indicates the level of noise signals relative to the channel. The system will automatically find a channel with lower noise signals. If usable frequencies or channels are found, the system will automatically save it and start pairing. The screen will display "55--", and after a few seconds, the "00--" on the screen disappears, indicating that the system has completed the entire process and automatically saved and exited.
- ④ Pressing ▲ button during the automatic search and pairing process can cancel the operation right away.

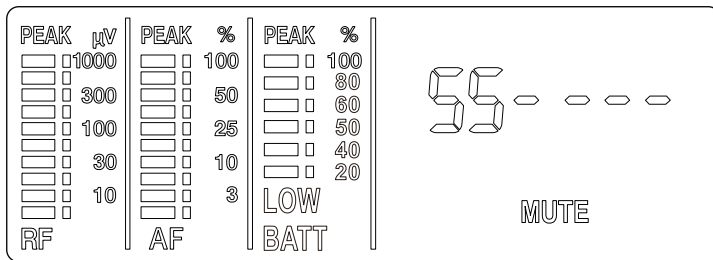

V. Volume Adjustment

Press and hold S/O button for 3 seconds to enter volume adjustment mode. Press ▲ or ▼ buttons to increase or decrease the volume, respectively. Press SET button to confirm and save the settings and exit.

VI. System Lock/Unlock Operation

When powered on, press and hold SET button for 2 seconds to lock the receiver. The screen displays a lock symbol, and when the receiver is locked, all other function buttons are disabled. Press and hold SET button for 2 seconds again to unlock, the lock symbol on the screen will disappear, and the other button functions will be restored.

VII. System Menu Settings

To access the system menu settings, press and hold ▲ key while powering on the device. The screen will display "-FSET-" and after 1 second, it will automatically switch to the flickering submenu SQL. Press SET key to cycle through the submenus SQL, RFP, LED, and ID. Within each submenu, use ▲ or ▼ keys to adjust the settings. Pressing the IR key during the operation to save and exit.

- ① SQL refers to the receiver sensitivity, with 11 levels ranging from -95dB to -75dB in 2dB increments. Use ▲ or ▼ keys to select the desired sensitivity level. Higher SQ settings improve anti-interference capability but may reduce the transmission distance, so adjust it as you see fit.
- ② RFP refers to the transmission power. After frequency pairing, select H for high power transmission and L for low power transmission. Use ▲ or ▼ keys to make the selection.
- ③ LED controls the backlight timeout duration. After frequency pairing, selecting ON will keep the backlight on, while selecting OFF will delay the backlight from turning off. Use ▲ or ▼ keys to make the selection.
- ④ ID determines whether pilot signal is enabled. Selecting ON will enable pilot signal, and selecting OFF will disable it. Use ▲ or ▼ keys to make the selection. When the pilot signal is detected, the corresponding PILOT characters will appear on the screen; otherwise, they will not be displayed. The pilot signal function is enabled by default upon power-on.

VIII. Recommendations for Use

1. Placing the Receiver

- ① After unpacking the receiver, connect the four receiving antennas to the antenna ports (ANT) of the receiver. Adjust two of the antennas to be oriented upwards and approximately perpendicular to the ground. This receiver is equipped with true diversity automatic selection. It has four receiving antennas, four complete receiving circuits, and diversity control circuits inside. Every two antennas and two receiving circuits handle the reception of one mic. For each mic, its two receiving antennas on the receiver are in different positions, resulting in noticeable differences in the received mic signals. The diversity control circuit will automatically compare and select the stronger signal to eliminate blind spots (dropouts) during reception.
- ② Avoid placing the receiver inside a metal cabinet as it can shield RF signals and affect the reception distance.
- ③ Keep the receiver away from DVD players, computers, karaoke machines, audio processors, LED displays, display processors, LED lighting fixtures, and lighting control devices. The stray interference signals emitted by these devices can also affect the reception distance.
- ④ Place the receiver as close to the performance area as possible and maintain a distance of at least 1.5 meters from large metallic objects, walls, scaffolding, and ceilings. Ensure a clear signal path between the mic and the receiver.

2. Checking and Connecting the Power

Before installation, check and ensure that the specifications of the receiver's power adapter match your local power specifications. If they do not match, do not proceed with the installation and usage, as it may damage the equipment or pose a safety hazard. Once you have confirmed the voltage compatibility, plug the output connector of the power adapter into the DC INPUT socket on the back of the receiver and plug the adapter into a power outlet.

3. Installation and Configuration for Using Multiple Sets in the Same Area

- ① Start by turning on one receiver without turning on any mics. Observe the RF signal indicator for the first channel of the receiver. If there is a signal, it indicates interference. Adjust the settings until there is no signal detected.
 - ② Turn on a mic and ensure that it functions properly in its intended location.
 - ③ While keeping the first mic on, observe the RF signal indicator for the second channel (repeat the step from the first channel to confirm there is no interference signal).
 - ④ Turn on the second mic and ensure that it functions properly in its intended location.
- Repeat these steps for the remaining mics, ensuring that all previously configured mics remain turned on. Continue with steps (b), (c), and (d) until all mics have been configured.

M-2F SERIES Wireless Microphone

⑤ After completing the above steps, close one mic at a time and check the RF indicator for each corresponding channel. Under normal circumstances, there should be no signal displayed on the channel when the mic is turned off. If a signal is present, you need to change the frequency. Check each channel again to ensure it meets the usage requirements.

Note: If the mic is damaged or lost and needs to be replaced, please use a spare mic and perform frequency synchronization with the receiver before use.

■ Safety Instructions

To avoid electric shock, overheat, fire, radiation, explosion, mechanical risk and injury or property loss due to improper use, please read and observe the following items before use:

1. Please check if the power of the connected equipment matches with that of this product before operation. Adjust the volume to proper level during operation. Do not operate at over-power or high-volume level for extended time to avoid product malfunction or hearing impairment.
2. If there is any abnormality during use (e.g., smoke, strange odor), please kill the power switch and unplug from power source, then send the product to the local after-sales service for repair.
3. Never use any replacement battery with broken insulation. Do not charge non-chargeable battery.
4. Dispose waste batteries in designated dustbin for sorting. Do not use them as children's toy nor discard directly to avoid health risk or environmental damage.
5. Keep this product and its accessories in a dry and ventilated area. Do not store in a humid or dusty area for extended time. Keep away from fire, rain, liquid intrusion, bumping, throwing, vibrating, or from blocking any ventilation openings, to prevent malfunction.
6. The product must, when installed on walls or ceilings, be fixed firmly in place at adequate strength to prevent from falling.
7. Please abide by safety rules during operation. Do not use the product in places prohibited by laws or regulations to avoid accident.
8. Do not disassemble or repair the product by yourself to avoid injury. If you have any questions or require any services, please contact our local after-sales service.

■ About This Manual

This manual contains up-to-date technical specifications as of printing. However, specifications contained herein may not conform to your particular product since Takstar is constantly improving its products. Also, specifications, devices or accessories available may vary from region to region. If you have any questions, please contact our local sales outlet. For the latest version/more information, please visit our website: <https://www.takstar.com/>

注意事项：

1. 本单为保修凭证，请用户妥善保管，如有遗失，恕不保修或退换。
2. 保修期限制：购买之日起十二个月内。
3. 除了不可抗力事件损坏外，由本公司负责，免费维修。
4. 如属保管不善或使用不当造成的损坏，维修点将酌情收费。
5. 擅自拆卸维修者，不予保修。
6. 以上保修条款仅限于中国市场适用（不含港澳台地区）。

产品服务保证书

姓名：_____ 电话：_____ 地址：_____

商品：_____ 型号：_____ 购买日期：_____ 年 ___ 月 ___ 日

维修记录栏 (由维修员填写)	维修员签名	日期

◆广东得胜电子有限公司 ◆电话：400-6828-333 ◆地址：广东省惠州市博罗县龙溪街道富康一路2号



扫一扫，了解更多产品
Scan for more
product information

广东省电声工程技术研究开发中心 广东得胜电子有限公司制造

地址：广东省惠州市博罗县龙溪街道富康一路2号

服务热线：400 6828 333 传真：0752 6383950

邮箱：xs@takstar.com

网址：www.takstar.com

Guangdong Takstar Electronic Co., Ltd.

Address: No. 2 Fu Kang Yi Rd., Longxi Boluo

Huizhou, Guangdong 516121 China

Tel: 86 752 6383644 Fax: 86 752 6383952

Email: sales@takstar.com

Website: www.takstar.com