



扫一扫，了解更多产品  
Scan for more  
product information

# TAKSTAR®

## User's Manual

# 用户手册

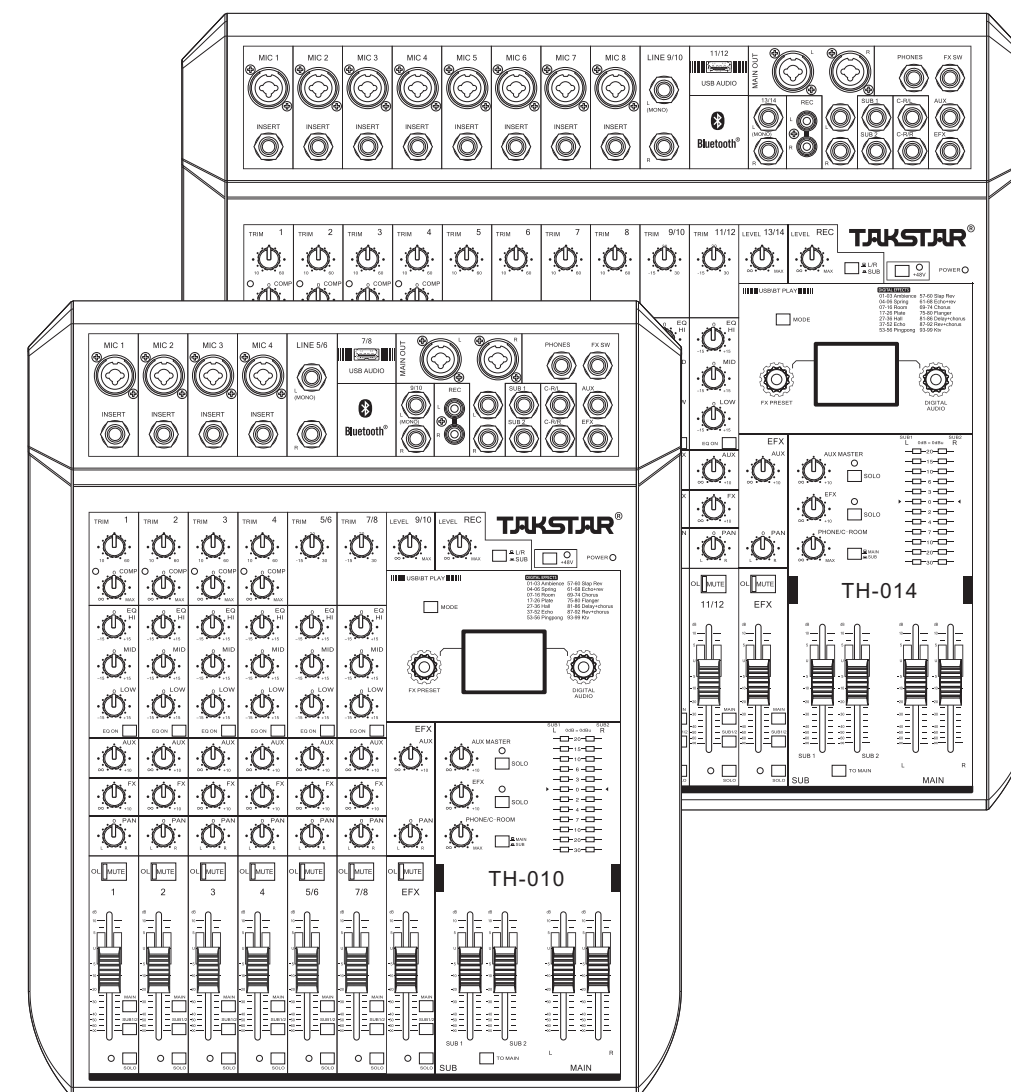

### 广东省电声工程技术研究开发中心 广东得胜电子有限公司制造

地址：广东省惠州市博罗县龙溪街道富康一路2号

服务热线：400 6828 333 传真：0752 6383950

邮箱：xs@takstar.com

网址：www.takstar.com

Guangdong Takstar Electronic Co., Ltd.

Address: No. 2 Fu Kang Yi Rd., Longxi Boluo

Huizhou, Guangdong 516121 China

Tel: 86 752 6383644 Fax: 86 752 6383952

Email: sales@takstar.com

Website: www.takstar.com

10/14 路输入  
多功能  
模拟调音台

\* 本说明书的内容为出版时最新的技术规格。

\* the contents of this manual are the latest technical specifications at the time of publication.



内部高压，小心触电



机器重要操作和维护提示



保护接地端子



交流电流/电压



危险带电端

表示设备开启

表示设备关闭



**警告**  
警示说明，需注意，  
避免可能受伤或死亡的危险。

**警告**  
警示说明，需注意以免造成产品  
损坏。产品的报废处理不能混于  
城市生活垃圾，需单独收集处理。

**警告**  
电源在接通机器电源之前，确保主电  
源电压与该机器所需电压一致，否则  
将对机器造成损坏或可能危害用户安  
全。机器长时间不用或打雷闪电时请  
拔出电源插头，以避免触电或火灾危  
险。

**外部连接**  
使用专用电源线连接，以免造成电击  
/死亡或火灾危险。若不明白，请联  
系技术人员处理。

**不要拆除任何外盖**  
机器内部有高压区，为了避免触电危  
险，在电源接通时不要拆除任何外盖  
。如有必要，请联系技术人员处理。

内部为非用户维修部件

**保险丝**  
为防止火灾及机器的损坏，确保使用  
指定规格保险丝，禁止使用不同规格  
保险丝。在换保险前，确保关闭机器  
电源，拔出电源插头。

**保护接地**  
开启机器前，确保与地连接，避免触电  
危险。严禁切断内部或外部的保护接地  
线或拔出保护接地端子。

**操作说明**  
请根据制造商的指示说明安装机器。  
为了避免触电和机器损坏，不要将机器  
置于雨水或潮湿环境。切勿在积水旁使  
用此机器。不要将机器安装于高温源附近  
不要阻塞任何通风口，以免引起火灾。  
机器远离明火。

**重要安全说明**  
-阅读安全说明  
-遵从安全说明  
-遵守安全说明  
-注意所有警示内容  
-只使用厂商指定配件

**电源线和插头**  
不要踩踏电源线或插头。  
不要断开保护接地连接。  
若提供的插头与您的AC座不配套，请联系  
技术人员更换电源插座。  
电源线与插头不要被重物压到以免有电击  
或火灾危险。

**清洁**  
当机器需要清洁时，可用吹风机或干净的  
布除去灰尘。  
不要使用清洁液，如不纯苯、酒精等。  
为了安全，请保持机器干净。

**机器的维修**  
所有维修事项请询求专业技术人员帮助，  
非专业人员请不要擅自处理，以免造成触  
电危险。

**便携式推车  
使用警告**



**推车和支架**  
只使用制造商推荐  
的推车或支架。  
小心使用，快速停止  
用力过猛和地面不平  
可能造成机器和推车  
翻倒。

## 简介

感谢您购买TAKSTAR TH系列多功能模拟调音台。

它拥有4/8路超低噪音的前置放大器、48V幻象电源、3路立体声输入、1路USB  
立体声输入；每路通道带有3段均衡EQ、录音、编组、监听、24字节数字效果器并  
配有99种效果选择。

在使用您的产品之前，请认真阅读用户说明书。

## 特性

- 10路输入，4路麦克风输入+3路立体声输入 (TH-010)  
14路输入，8路麦克风输入+3路立体声输入 (TH-014)
- 主声道L/R，SUB编组，SOLO独奏等母线信号分配按钮
- 内置99种24BIT DSP 参数可调音频效果器，数字显示屏
- 通道3段参量均衡器+四通道独立的压缩器
- SUB1/2编组输出
- 双12段电平监视
- PAN声像定位，静音开关，信号失真监控灯
- 2路立体声辅助返回输入+PC USB-A 2.0数据接口+蓝牙输入，  
可用于USB播放，外接其他电子设备，方便使用
- AUX辅助发送，效果FX发送功能，REC莲花录音输出
- 监听独立输出，耳机监听输出
- 60mm高精度电平衰减推子
- 48V幻象供电

## 适用范围

适用范围：适用于各种中小型活动，会议，多功能厅，小型演出。

# 目录

注意事项 .....	1
安装示例 (前面板) .....	4
面板功能介绍 .....	5
1. [MIC/LINE] 输入插口/XLR接口 .....	5
2. [INSERT] 输入插口/XLR接口 .....	5
3. [LINE 9/10] 立体声输入插口 .....	5
4. USB 闪存播放接口 .....	5
5. [LINE 13/14] 立体声输入插口 .....	5
6. [REC] 录音输出接口 .....	5
7. [SUB] 编组输出 1-2 .....	5
8. [CR OUT] 监听输出 (L、R) .....	6
9/10. [AUX / EFX] 辅助发送接口 .....	6
11. [FX SW] 踏板开关插口 .....	6
12. [PHONES] 耳机接口 .....	6
13. [MAIN OUT] 左右主输出 .....	6
14. [GAIN] 增益旋钮 .....	7
15. [COMP] 压缩/限幅旋钮 .....	7
16. [EQ] 均衡 .....	7
[HI] 高音	
[MID] 中音	
[LOW] 低音	
17. [PRE/POST] 置前/置后 切换按键 .....	7
18. [AUX] 辅助发送 .....	7
19. [FX] 效果辅助 .....	7
20. [PAN] 声像旋钮 .....	7
21. [MUTE] 静音按键 .....	7
22. 推子 .....	8
23. [MAIN] 主通道和 [SUB 1/2] 编组分配按钮 1/2 .....	8
24. [SOLO] 监听+监听灯 .....	8
25. [LEVEL] 13/14 音量旋钮 .....	8
26. [REC LEVEL] 录音音量旋钮 .....	8
27. [SUB / L、R] 录音切换 .....	8
28. [+48V] LED 灯 .....	8
29. [POWER] 电源灯 .....	8

30. 显示屏 .....	9
31. [DIGITAL AUDIO] 旋钮 .....	9
32. [FX PRESET] 旋钮 .....	9
33. [AUX MASTER] 主控旋钮 .....	9
[SOLO] 监听按键	
34. [EFX] 旋钮 .....	9
[SOLO] 监听按键	
35. [CONTROL ROOM/PHONE] 旋钮 .....	9
[SUB/L、R] 切	
36. 左/右电平表 .....	9
37. [EFX] 效果推子 .....	10
38. [SUB 1/2] 编组控制推子 .....	10
39. 主通道混合推子 .....	10

## 背板功能介绍 .....

40. [AC] 电源连接口 .....	11
41. [POWER] 电源开关 .....	11

## 技术规格 .....

## 安全警示 .....

# 安装示例

## 前面板

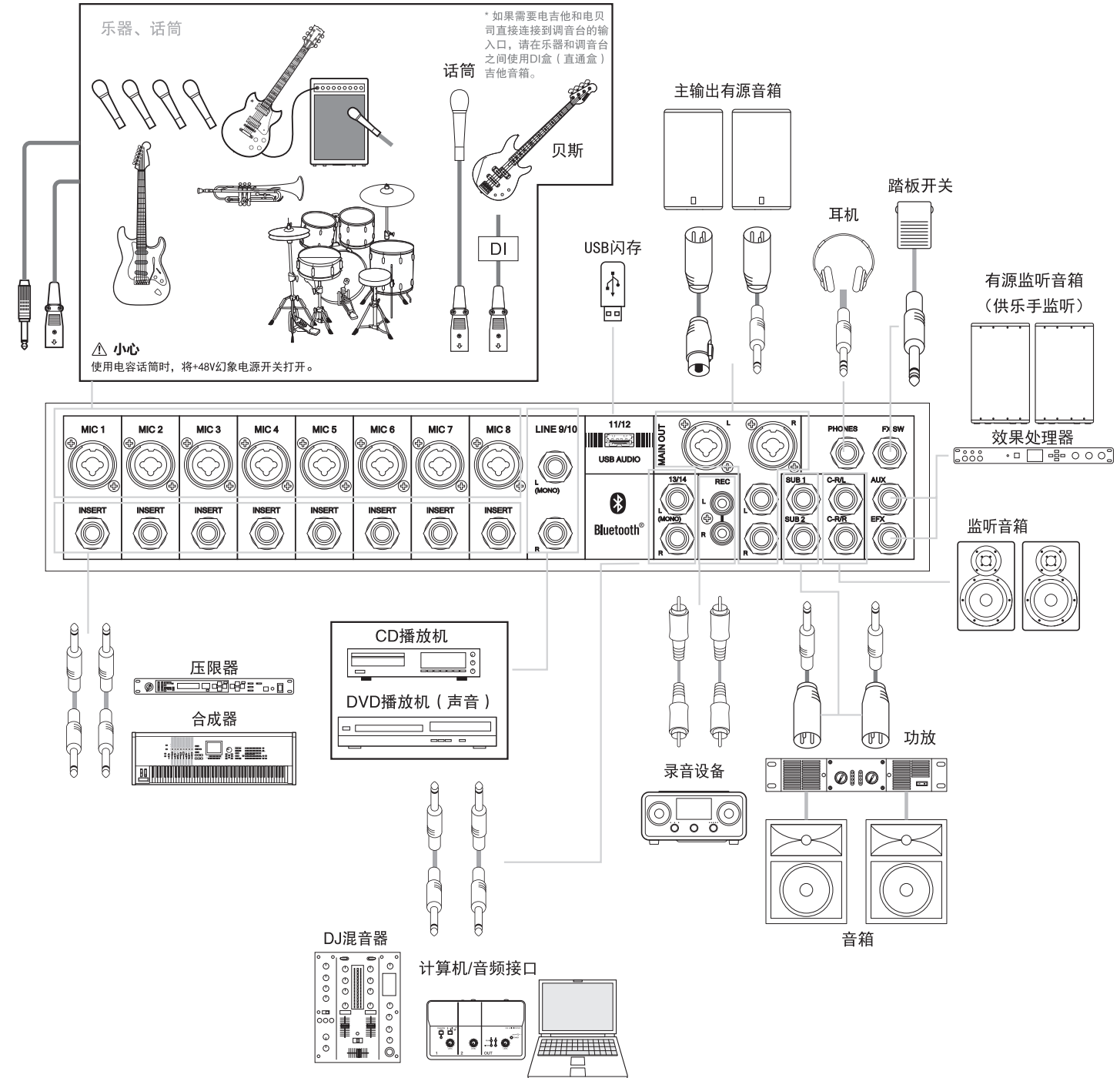

# 面板功能介绍

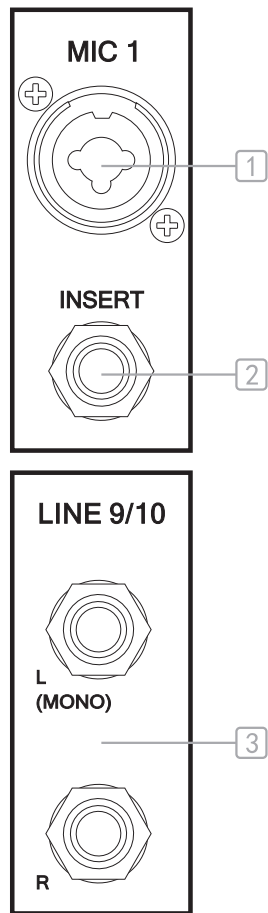

## 1.[MIC/LINE]输入插口/XLR接口

用于连接话筒、乐器或外置音频设备。多功能插口既支持XLR又支持PHONE型插头。



## 2.[INSERT]输入插口/XLR接口

INSERT:这些是TRS (尖=发送/输出; 环=返回/输入; 套=接地) phone型双向插头。可以使用这些插口将通道连接到设备, 如图示均衡器、压缩器和噪音过滤器。

注: 连接到INSERT插口需要使用如下图所示的专用插入线缆。

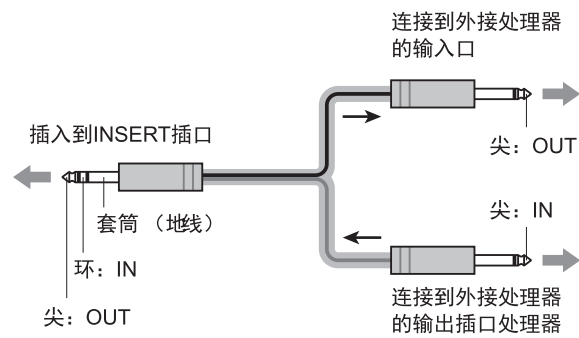

## 3.[LINE 9/10]立体声输入插口

非平衡phone 型线路立体声输入插口。

## 4.USB闪存播放接口

通过机器内置MP3播放器和录音机, 直接播放USB闪存内的歌曲或其它音频文件。支持格式:MP3,WAV,WMA。

### ■ USB 闪存容量和格式

USB 闪存的操作已被证实兼容最高64GB 的闪存。  
(但不保证能使用所有种类的USB 闪存存储器。)支持FAT16 和FAT32 格式。

### ■ 避免意外删除

某些USB 闪存设备具有保护设定, 可防止数据被意外删除。如果您的闪存设备含有重要数据, 强烈推荐您使用写保护设定防止数据被意外删除。

## 5.[LINE 13/14]立体声输入插口

立体声输入插口: 用于连接线路信号设备, 如电子键盘或音频设备。用[L/MONO]插口连接单声道输出的乐器等。在这种情况下, 输入到[L/MONO]插口的声音会从调音台的左右两个通道同时输出。

## 6.[REC]录音输出接口

录音输出: 仅限 ( REC立体声通道使用非平衡RCA接口 ( TAPE INPUT ) 连接立体声线路信号, 例如录音机、CD机、MP3播放机, 电视声音等等.....

## 7.[SUB]编组输出 1-2

这些阻抗平衡 1/4" TRS 插口可输出编组 ( SUB ) 1-2 的信号。可用这些插口连接多轨录音机、外接调音台或其它此类设备的输入口。

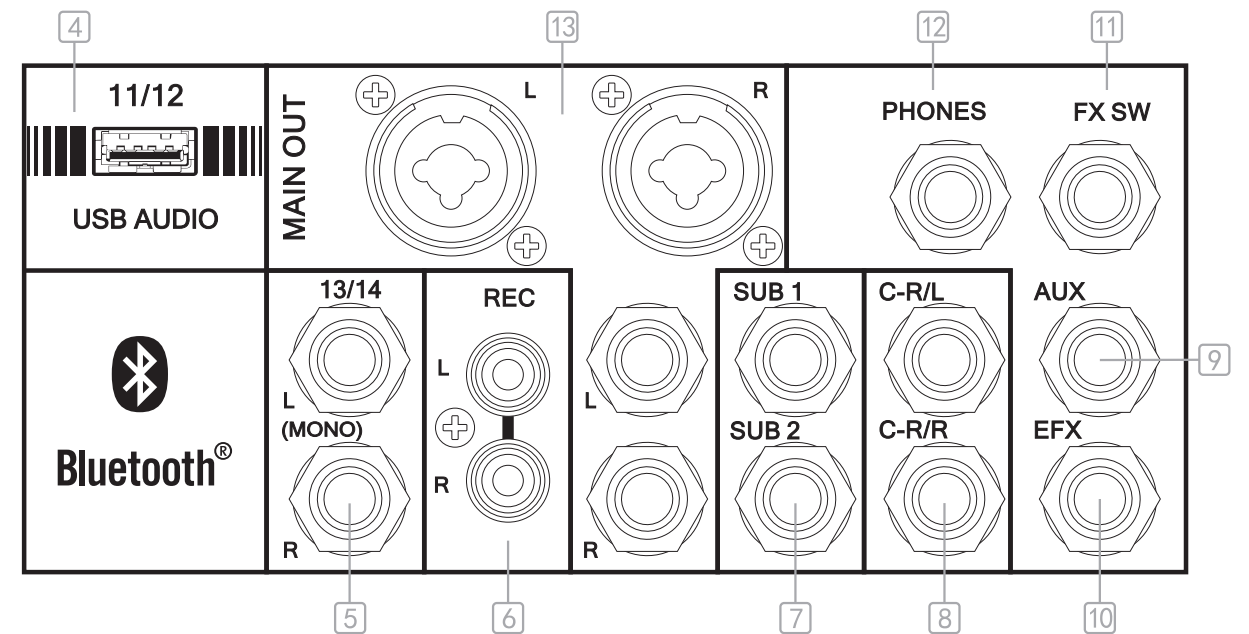

## 8.[CR OUT]监听输出 ( L、R )

这些插口是阻抗平衡1/4"TRS型输出插口, 可连接到监听系统。这些插口向各个总线输出推子前或推子后信号。各功能区中的SOLO指示灯表示哪个信号正被输出。

注

SOLO开关打开的情况下, SOLO开关具有优先权。如要监听推子前信号, 请确保关闭所有SOLO开关。

## 9/10.[AUX / EFX ]辅助发送接口

AUX/EFX这些插口可连接诸如外接效果器设备或舞台/ 工作室等监听系统输出。这些是阻抗平衡式 "phone" 型输出插口。

### ■ 阻抗平衡式

由于阻抗平衡式输出插口的热端子和冷端子具有相同的阻抗, 原本存在的噪声对这些输出插口影响不大。

## 11.[FX SW]踏板开关插口

将踏板开关连接到这个phone 型输入插口。可以用选购的踏板开关打开或关闭效果。

## 12.[PHONES]耳机接口

用于连接耳机。该插口支持立体声phone型插头。

如需连接带有mini插头的头戴耳机或耳塞, 请使用[转换设备]来进行连接。

## 13.[MAIN OUT]左右主输出

这里有两套为主输出而设的接口: 凸形XLR插孔提供平衡的线路信号; 1/4" TRS插孔提供平衡或者非平衡的信号。每一个XLR插孔都是平行于与它对应的1/4" TRS插孔, 而且负载相同的信号。这代表着整个混音链的最后部分, 连接这些插孔到你的主功放上, 有源音箱, 或者一系列效果处理器, 让你的混音信号真实体现出来。

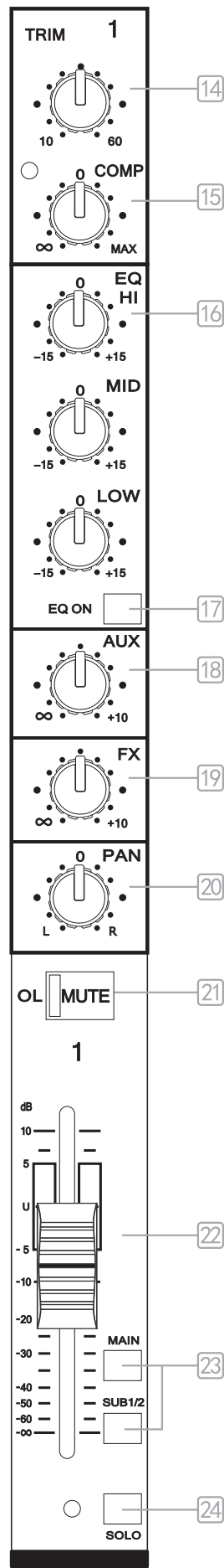

#### 14.[GAIN]增益旋钮

设置提供给此通道的话筒或线路输入信号的音量。这个GAIN旋钮是用来调节话筒和线路输入信号的灵敏度的。这使外来的信号被调节到理想的内部控制电平。

#### 15.[COMP]压缩/限幅旋钮

调节应用到通道的压缩的效果量。随着旋钮向右旋转，压缩率将增大，同时输出增益也会相应地自动调节。这样可以获得一个更平滑、更平均的动态，这是由于整体电平提升后大动态的信号被衰减所致。当压缩器运行时，COMP 指示灯将亮起。

注意：由于较高平均输出电平会产生反馈，因此避免将压缩率设得太高。

#### 16.[EQ]均衡

##### 一. [HI]高音

控制此通道的高频段信号，请将旋钮调节到12点的位置，你可以根据扬声器，聆听位置和听众的口味来控制信号，对通道12kHz内的信号控制提升或衰减。

##### 二. [MID]中音

控制此通道的中频段信号，请将旋钮调节到12点的位置，你可以根据扬声器，聆听位置和听众的口味来控制信号，对通道2.5kHz内的信号控制提升或衰减。

##### 三. [LOW]低音

控制此通道的低频段信号，请将旋钮调节到12点的位置，你可以根据扬声器，聆听位置和听众的口味来控制信号，对通道80Hz内的信号控制提升或衰减。可增强低音鼓、低音贝司等乐器的效果。

#### 17. [EQ ON]切换按键

这个按键是让进入通道的信号是否添加EQ效果。当按键是按下时，EQ功能不会对信号产生效果。当按键是弹起时，信号受EQ控制产生相应的效果。这样的话你就能比较加了EQ与不加EQ的效果。

#### 18. [AUX]辅助发送

该旋钮用于控制此通道的辅助发送信号大小，该信号经主控制AUX SEND旋钮控制为发送到外部设备，如效果器等。

通常情况下，这些控制有两个功能：

- 第一，用来控制效果的电平，例如控制被加载在输入信号上的外置效果处理设备的混响效果。
- 第二，在录音室或舞台上建立独立的音乐返听混音。（输出的信号是推子后）

#### 19.[FX]效果辅助

这些旋钮利用每个通道的信号发送到机内效果器处理后，返回到立体声主通道。通道推子，静音和其他通道控制会影响到效果输出，但声相调节不会（效果辅助是在推子后）。

#### 20.[PAN]声相旋钮

这个旋钮是用来调节声源的左右分布，在立体声混音或可能用在当使用路由开关路由(发送)信号到特定的编组输出时确定信号的为位置。适用于调节该路声源在空间的分布图像。当往左调节时当于把该路声源放在听音的左边，当往右调节时当于把该路声源放在听音的右边。若把它置于中间位置时相当于把该路声源放在听音的正中。它对于调音台创作立体声输出极为重要。

#### 21.[MUTE]静音+OL失真灯

##### 1.MUTE静音键

按下(■)此开关，通道会静音。用来开关通道并对于当前不用的通道进行隔离或对通道电平预调整非常有用。用于决定混音中输入信号的电平以及提供可见的通道电平指示。

- 此开关被设定为开或关都可以通过PHONES 插口监听通道前置推子。
- 为了减少噪音，请将所有不使用的通道关闭。

##### 2.OL失真灯(与MUTE灯共用)

当通道的均衡后信号电平到削波失真以下3 dB 时会亮起成红色。

注：在MUTE静音键未按下的前提下才显示OL失真灯。

#### 22.推子

调节输入通道信号的输出电平。用这些推子调节各通道之间的平衡。

注：为了减小噪音，将不使用的通道的推子调节到最低。

#### 23.[MAIN]主通道和[SUB1/2]编组分配按钮

这些开关决定每个通道的信号要被发送到哪个总线。按下该开关(■)可以将信号输出到对应编组（总线）。

- 开关1-2：将通道的信号分配到SUB1-2 编组（总线）。
- MAIN开关：将通道信号分配到主通道 L 和R 总线。

注：要将信号发送到各总线，请打开MUTE开关。

#### 24.[SOLO]监听+监听灯

监听按键SOLO：推子衰减前的监听，按下后，旁边的LED灯会亮起来，这时用耳机插在调音台的耳机插孔便能听见该路推子前的声音信号。

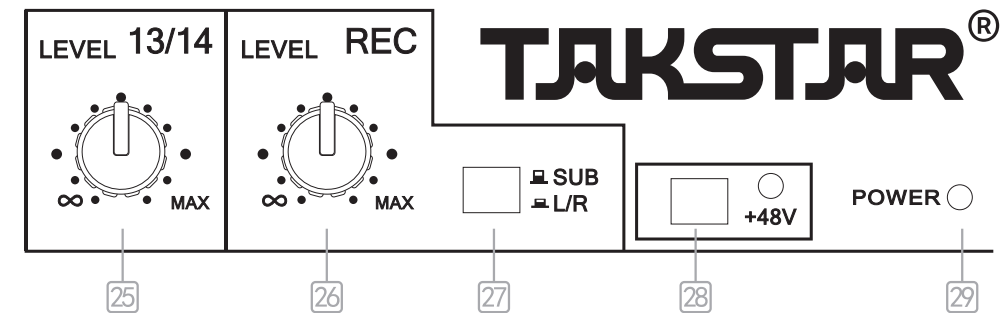

#### 25.[LEVEL]13/14 音量旋钮

用于调节输入该通道信号的输出电平。注：为了减小噪音，不使用时请调节到最低。

#### 26.[REC LEVEL] 录音音量旋钮

调节录音输出信号电平。

#### 27.[SUB / L、R] 录音切换

用于切换SUB(编组) / MAIN(主通道) 录制信号。

#### 28.[+48V]幻像电源开关和LED灯

当幻像电源开关打开(■)时，[+48V]LED灯会亮起，DC +48V幻像供电会供应给输入插口上的XLR插头设备。使用需要幻像供电的电容话筒时，请打开此开关。

##### 须知

如果不需要幻像电源时，请务必将该开关设定为关闭(■)。打开(■)时，为防止产生噪音以及调音台和外接设备的损坏，请遵守下列重要注意事项：

- 1.在通道上连接不支持幻像供电的设备时，确保该开关保持在关闭(■)状态。
- 2.从通道上连接/断开线缆时，确保关闭(■)开关。
- 3.打开(■) / 关闭(■)该开关之前，请将通道上的推子拉到最下方。

#### 29.[POWER]电源灯

当电源开关打开时，调音台的POWER电源指示灯会亮灯。



警告：• 请不要拨下插头的接地引脚。

• 严格按照产品标示电压来使用。

• 连续快速打开和关闭本机电源可能会导致其发生故障。关闭本机后，请等待约6秒钟后再再次打开。

• 即使电源开关已经关闭，也会有最小的电流通向本产品。确定长时间不使用本产品时，请务必将电源插头从交流电源插座拔出。

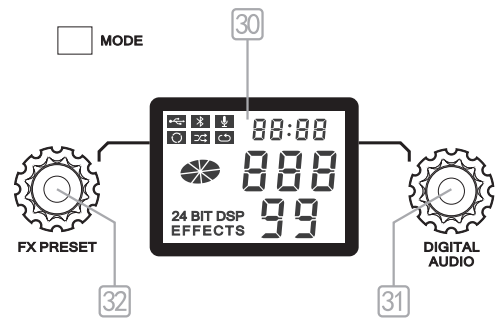

### 31. [DIGITAL AUDIO]旋钮

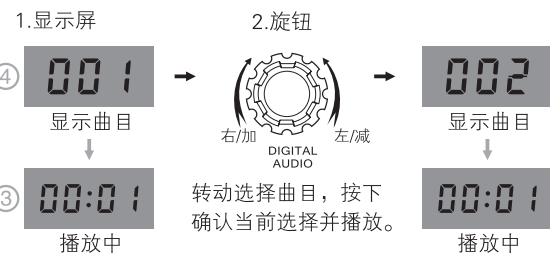

### 32. [FX PRESET]旋钮



### 30.DISPLAY

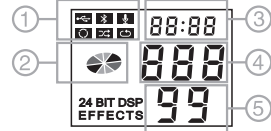

- 1.功能显示
- 2.运行状态或蓝牙连接状态显示
- 3.曲目时间显示
- 4.曲目数显示
- 5.效果显示  
(请参考右边效果种类表)

### DIGITAL EFFECTS

01-03 Ambience	57-60 Slap Rev
04-06 Spring	61-68 Echo+rev
07-16 Room	69-74 Chorus
17-26 Plate	75-80 Flanger
27-36 Hall	81-86 Delay+chorus
37-52 Echo	87-92 Rev+chorus
53-56 Pingpong	93-99 Ktv

### 操作控制简介

- 一、MODE (轻触按键): 短按: 预选模式, 相应模式图标闪烁显示, 依次为U盘、蓝牙、录音、顺序播放、随机播放、单曲循环 (短按DIGITAL AUDIO键确认切换)。
- 二、MODE (轻触按键): 长按:
  - 1、在录音模式下, 停止录音状态下, 可进入播放录音文件模式。
  - 2、在非录音模式下, 可快捷进入播放录音文件模式。
- 三、DIGITAL AUDIO (编码器按键): 短按:
  - 1、控制运行或暂停 (包括播放与录音)。
  - 2、模式图标闪烁时, 确认切换当前闪烁显示的模式。
  - 3、转动编码器至预选播放曲目, 确认播放当前对应歌曲。
- 四、DIGITAL AUDIO (编码器按键): 长按:
  - 1、控制停止 (包括播放与录音)。
  - 2、当录音已停止, 可进入播放录音文件模式。
  - 3、在蓝牙模式下, 可断开当前蓝牙连接。
- 五、编码器:
  - 1、U盘播放时, 预选播放曲目。
  - 2、蓝牙、录音文件播放时, 切换上/下曲。
- 六、播放录音文件时, 同时显示U盘和录音的图标以作指示。

### 33.[AUX MASTER]主控旋钮+[SOLO]监听按键

- 1.控制从AUX输出发出的信号的总体水平。这种辅助输出通常被用于功率放大器驱动舞台监视器, 这样歌手就可以在放大的乐器中听到自己的声音, 或者用于耳机放大器, 这样歌手在录音时就不会被麦克风接收到监控信号。
- 2.当SOLO监听键按下后, 灯亮。便能从监视器、监听音箱、监听耳机听见连接[AUX]接口设备的声音信号。

### 34.[EFX]旋钮+[SOLO]监听按键

- 1.控制从EFX输出发出的信号的总体水平。这种通常被用于控制连接外部效果器的信号音量。
- 2.当SOLO监听键按下后, 灯亮。便能从监视器、监听音箱、监听耳机听见连接[EFX]接口的外部效果的声音信号。

### 35.[CONTROL ROOM/PHONE]旋钮+ [SUB/L、R]切换键

- 1.[CONTROL ROOM/PHONE]旋钮: 调节输出到监听音箱/监听耳机的信号。
- 2.[SUB/L、R]切换按键: 通过切换按键来选择主输出或编组, 输入信号被发送到监听音箱/监听耳机输出。

### 36. 左/右电平表

调音台的左右电平表是有两列12盏LED灯组成的, LED分别有三种颜色来指示电平的范围。

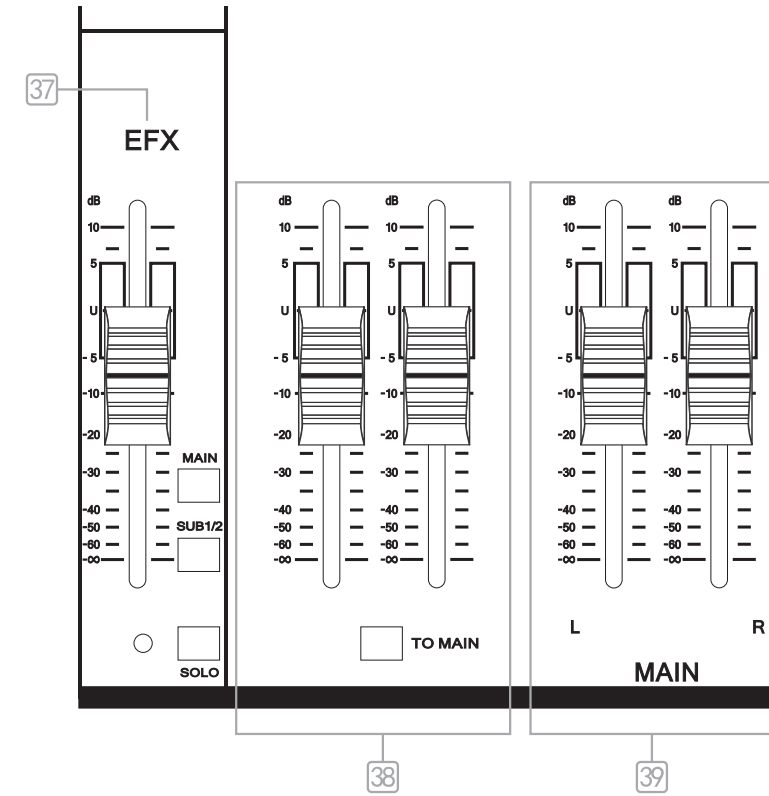
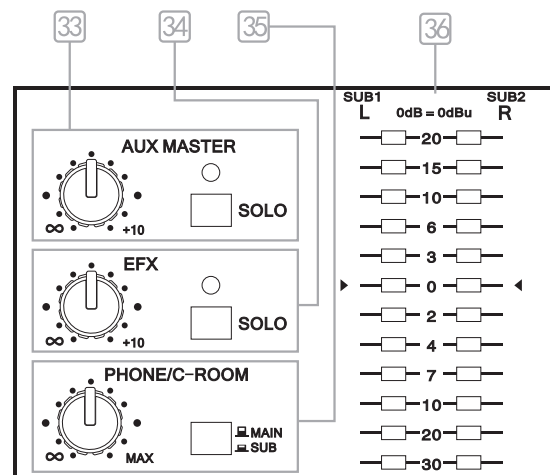

### 37. [EFX]效果推子

这个推子可以控制调整内部效果器返回到主通道母线的信号, 从而调整到效果音量。

### 38. [SUB 1/2]编组控制推子

这些推子控制编组信号的电平, 由“off”到“U”统一增益, 然后再到10dB的额外增益。

### 39.主通道混合推子

这些推子控制主混音的电平和影响电平表和主线路电平输出。你可以控制听众们所听到的声音, 确保不会出现问题。如出现问题, 请仔细调整, 看清楚电平表是否超负荷以及确保输出的电平可以令观众满意。



主混音信号的推子要完全调低, “U”标记是单位增益, 可提高额外增益10dB, 额外增益多少可以在此处看到。电平控制是立体的, 可同时对左右主混音调整。当你在演出和歌曲结尾时想声音很好地消失, 请在完结时将推子推低。

## 背板功能介绍

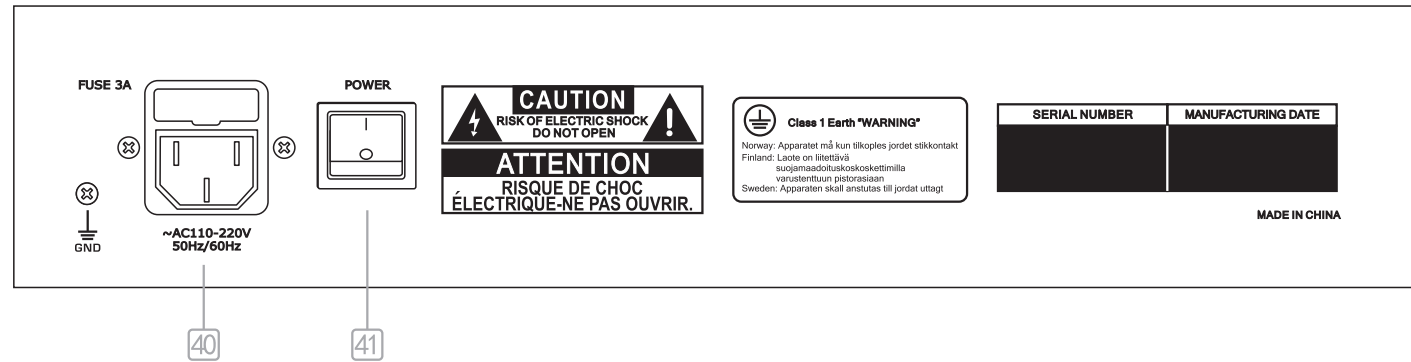

### 40.[AC]电源接口

标准的IEC电源接口，如果掉失本调音台所提供的电源线,也可使用专业的录像机、乐器、计算机的三孔IEC线连接使用。

### 41.[POWER]电源开关

用于将本设备的电源设置为待机(O)和打开(I)。当开关设置为打开(I)时,面板上的[POWER]LED灯会亮。

注:1.连续快速在开机与关机之间切换,会造成设备的损坏.请勿尝试。  
正确方式应将电源设置为待机后,请等待大约6秒钟后,才再次打开。

2.即使开关处于待机(O)状态,仍会有少量电流进入设备。如果在一段时间内不使用本设备,请务必将DC电源线拔出

## 技术规格

0 dBu=0.775 Vrms, 0 dBV=1 Vrms

如果没有指定所有推子将设定到标称位置。(标称位置被调整到低于最大位置 10 dB)

信号发生器的输出阻抗 (Rs)=100 ohm, 输出负载阻抗 =100k ohm (TRS phone 型输出)

	INPUT	OUTPUT	CHANNEL (单声道)		STEREO (立体声)	RETURN 返回
			MIC(咪放)	LINE(线路)	LINE(线路)	
增益 GAIN (0dBu)	GAIN (0dBu)		10~60	-10~40	-20~20	
	AUX 辅助	0dB(PRE) (推子前)				
		0dB ( POST) (推子后)	10	-10	-22	
		MAX(POST) (推子后)	81	61	33	
	MONITOR OUT (监听输出)	MAX ( ALL MAX ) 所有增益电位器最大	78	64	43	40
		0dB(GAIN Control at MIN) 增益电位器最小	5	-16	9	15
	PHONES OUT (耳机输出)	MAX ( ALL MAX ) 所有增益电位器最大	84	61	50	40
		0dB(GAIN Control at MIN) 增益电位器最小	10	0	15	15
	GROUP OUT (编组输出)	MAX ( ALL MAX ) 所有增益电位器最大	56	67	46	
		0dB(GAIN Control at MIN) 增益电位器最小	15	-5	17	
STEREO OUT (立体声输出)	MAX ( ALL MAX ) 所有增益电位器最大	86	67	46	19	
	0dB(GAIN Control at MIN) 增益电位器最小	15	-5	17	0	
CH INSERT OUT (通道加插输出)	MAX ( ALL MAX ) 所有增益电位器最大	60	44			
	0dB(GAIN Control at MIN) 增益电位器最小	11	-13			
REC OUT (莲花录音输出)	MAX 增益电位器最大	75	60	38		
TH-010 信噪比 Signal to Noise Ratio	STEREO OUT (立体声输出)	80	65	85		
	PHONES OUT (耳机输出)	79	66	86		
TH-014 信噪比 Signal to Noise Ratio	STEREO OUT (立体声输出)	85	70	90		
	PHONES OUT (耳机输出)	85	75	90		
噪声 Noise (Control at MIN)	PHONES OUT (Fader at 0dB) 监听耳机输出(推子最小)		-90			
	STEREO OUT(Fader at 0dB) 立体声输出(推子在0dB位)		-73			
	TH-010 STEREO OUT (Fader at MIN) 立体声输出(推子最小)		-87			
	TH-014 STEREO OUT (Fader at MIN) 立体声输出(推子最小)		-90			
	CH INSERT OUT (通道加插输出)		-95			

本使用说明书的内容为印刷时最新的技术规格。由于产品会不断改善,可能本说明书中的规格与您的产品规格不符,请至网站下载最新版本的使用说明书。技术规格、设备或选购配件在各个地区可能会有所不同,因此如有问题,请与当地经销商联系并确认。

## ■ 安全警示

为避免电击、高温、着火、辐射、爆炸、机械危险以及使用不当等可能造成的人身伤害或财产损失，使用本产品，请仔细阅读并遵守以下事项：

1. 使用产品时请确认所连接设备与本产品功率是否匹配以及合理调整音量大小，不要在超过产品功率及大音量下长时间使用，以免造成产品异常和听力损伤；
2. 使用中若发现有异常（如冒烟、异味等），请立即关闭电源开关并拔掉电源插头，然后将产品送经销商检修；
3. 本产品及配件都应放置在室内干燥通风处，勿长期存放在潮湿、灰尘多的环境，使用中避免靠近火源、雨淋、进水、过度碰撞、抛掷、振动本机及覆盖通风孔，以免损坏其功能；
4. 若产品需要固定于墙壁或天花板上时，请确保固定到位，防止因固定强度不足导致产品发生跌落危险；
5. 使用该产品时需遵守相关安全规定，法律法规明确禁止使用场合请勿使用本机，以免导致意外事故；
6. 请不要自行拆机改装或维修，以防止出现人身伤害，如有问题或服务需求请联系当地经销商跟进处理。



仅适用于海拔2000  
米以下地区使用



仅适用于非热带  
气候条件下使用

## Important Safety Instructions



This symbol, wherever used, alerts you to the presence of un-insulated and dangerous voltages within the product enclosure. These are voltages that may be sufficient to constitute the risk of electric shock or death.



This symbol, wherever used, alerts you to important operating and maintenance instructions.

Please read.



Protective Ground Terminal



AC mains (Alternating Current)

AC mains (Alternating Current)

ON:

Denotes the product is turned on.

OFF:

Denotes the product is turned off.

### WARNING

Describes precautions that should be observed to prevent the possibility of death or injury to the user.



### CAUTION

Describes precautions that should be observed to prevent damage to the product.  
Disposing of this product should not be placed in municipal waste but rather in a separate collection.

### WARNING

#### Power Supply

Ensure that them a inssource voltage (AC outlet) matches the voltage rating of the product. Failure to do so could result in damage to the product and possibly the user. Unplug the product before electrical storms occur and when unused for long periods of time to reduce the risk of electric shock or fire.

#### External Connection

Always use proper ready-made insulated mains cabling (power cord). Failure to do so could result in shock/death or fire. If in doubt, seek advice from a registered electrician.

#### Do Not Remove Any Covers

Within the product are areas where high voltages may present. To reduce the risk of electric shock do not remove any covers unless the AC mains power cord is removed. Covers should be removed by qualified service personnel only.

No user serviceable parts inside.

#### Fuse

To prevent fire and damage to the product, use only the recommended fuse type as indicated in this manual. Do not short-circuit the fuse holder. Before replacing the fuse, make sure that the product is OFF and disconnected from the AC outlet.

#### Protective Ground

Before turning the unit ON, make sure that it is connected to Ground. This is to prevent the risk of electric shock.

Never cut internal or external Ground wires. Like wise, never remove Ground wiring from the Protective Ground Terminal.

#### Operating Conditions

Always install in accordance with the manufacturer's instructions.

To avoid the risk of electric shock and damage, do not subject this product to any liquid/rain or moisture.

Do not use this product when in close proximity to water.

Do not install this product near any direct heat source. Do not block areas of ventilation. Failure to do so could result in fire.

Keep product away from naked flames.

### IMPORTANT SAFETY INSTRUCTIONS

Read these instructions

Follow all instructions

Keep these instructions. Do not discard.

Heed all warnings.

Only use attachments / accessories specified by the manufacturer.

#### Power Cord and Plug

Do not tamper with the power cord or plug. These are designed for your safety.

Do not remove Ground connections!

If the plug does not fit your AC out let seek advice from a qualified electrician.

Protect the power cord and plug from any physical stress to avoid risk of electric shock.

Do not place heavy objects on the power cord. This could cause electric shock or fire.

#### Cleaning

When required, either blow off dust from the product or use a dry cloth.

Do not use any solvents such as Benzol or Alcohol.

For safety, keep product clean and free from dust.

#### Servicing

Refer all servicing to qualified service personnel only.

Do not perform any servicing other than those instructions contained within the User's Manual.

### PORTABLE CART WARNING



Carts and stands - The component should be used only with a cart or stand that is recommended by the manufacturer. A component and cart combination should be moved with care. Quick stops, excessive force, and uneven surfaces may cause the component and cart combination to overturn.



## Introduction

---

Thank you for purchasing this multi-function analog TH series mixer from TAKSTAR.

It has 4 / 8 way ultra low noise preamplifier, 48V phantom power, 3 way stereo input, 1 way USB stand Body sound input; each channel with 3 balanced EQ、REC、SUB、Monitor、24-byte digital effectors.  
There are 99 effect options.

Please read the user instructions carefully before using your product.

## Features

---

- 10 inputs,including 4 mics+ 3 Stereos(L+R) ( TH-010)  
14 inputs,including 8 mics+ 3 Stereos(L+R) ( TH-014)
- L/R on main channel, SUB group, SOLO and other bus signal distribution buttons
- Built-in 99 kinds of 24BIT DSP +digital display
- 3 band EQ + 4ch independent compression
- Group output of SUB1/2
- Double 12 level monitoring
- PAN,MUTE, THD signal lamp
- 2 stereo aux return input+PC USB-A 2.0 interface+Bluetooth input, can be used for USB playback and other electronic equipment
- Aux + effect FX send ,REC recording output
- Independent monitoring + Headphones monitoring for output
- 60mm logarithmic fader
- 48V phantom power supply

## Application

---

Suitable for all kinds of small & medium activities, conferences, multi-function hall, small performance

## Contents

**Cautions** ..... 14

**INSTALL SAMPLE(FRONT PANEL)**..... 17

**Panel Function** ..... 18

1.[MIC/LINE] .....	18
2.[INSERT] .....	18
3.[LINE 9/10] .....	18
4.USB .....	18
5.[LINE 13/14].....	18
6.[REC] .....	18
7.[SUB] .....	18
8.[CR OUT] ( L、 R ) .....	19
9/10.[AUX / EFX ].....	19
11.[FX SW] .....	19
12.[PHONES].....	19
13.[MAIN OUT] .....	19
14.[GAIN].....	20
15.[COMP] .....	20
16.[EQ] .....	20
[HI]	
[MID]	
[LOW]	
17. [PRE/POST] Switch .....	20
18. [AUX] .....	20
19.[FX] .....	20
20.[PAN] .....	20
21.[MUTE] .....	20
22.CHANNEL FADER.....	21
23.[MAIN] and [SUB1/2] Switch .....	21
24.[SOLO].....	21
25.[LEVEL 13/14] Knod.....	21
26.[REC LEVEL] Knod.....	21
27.[SUB / L、 R] Switch.....	21
28.[+48V] Phantom .....	21
29.[POWER] Led .....	21

30.DISPLAY .....	22
31. [DIGITAL AUDIO] Knod .....	22
32. [FX PRESET] Knod .....	22
33.[AUX MASTER] Knod .....	22
[SOLO] Keyswitch	
34.[EFX] Knod .....	22
[SOLO] Keyswitch	
35.[CONTROL ROOM/PHONE] Knod .....	22
[SUB/L、 R] Switch	
36. METERS .....	22
37. [EFX] FADER .....	23
38. [SUB 1/2] FADER .....	23
39.MAIN FADER .....	23

**Back panel function** ..... 24

40.[AC] POWER JACK .....	24
41.[POWER] POWER SWITCH .....	24

**Specifications** ..... 25

**Safety warnings** ..... 26

# INSTALL SAMPLE

## FRONT PANEL

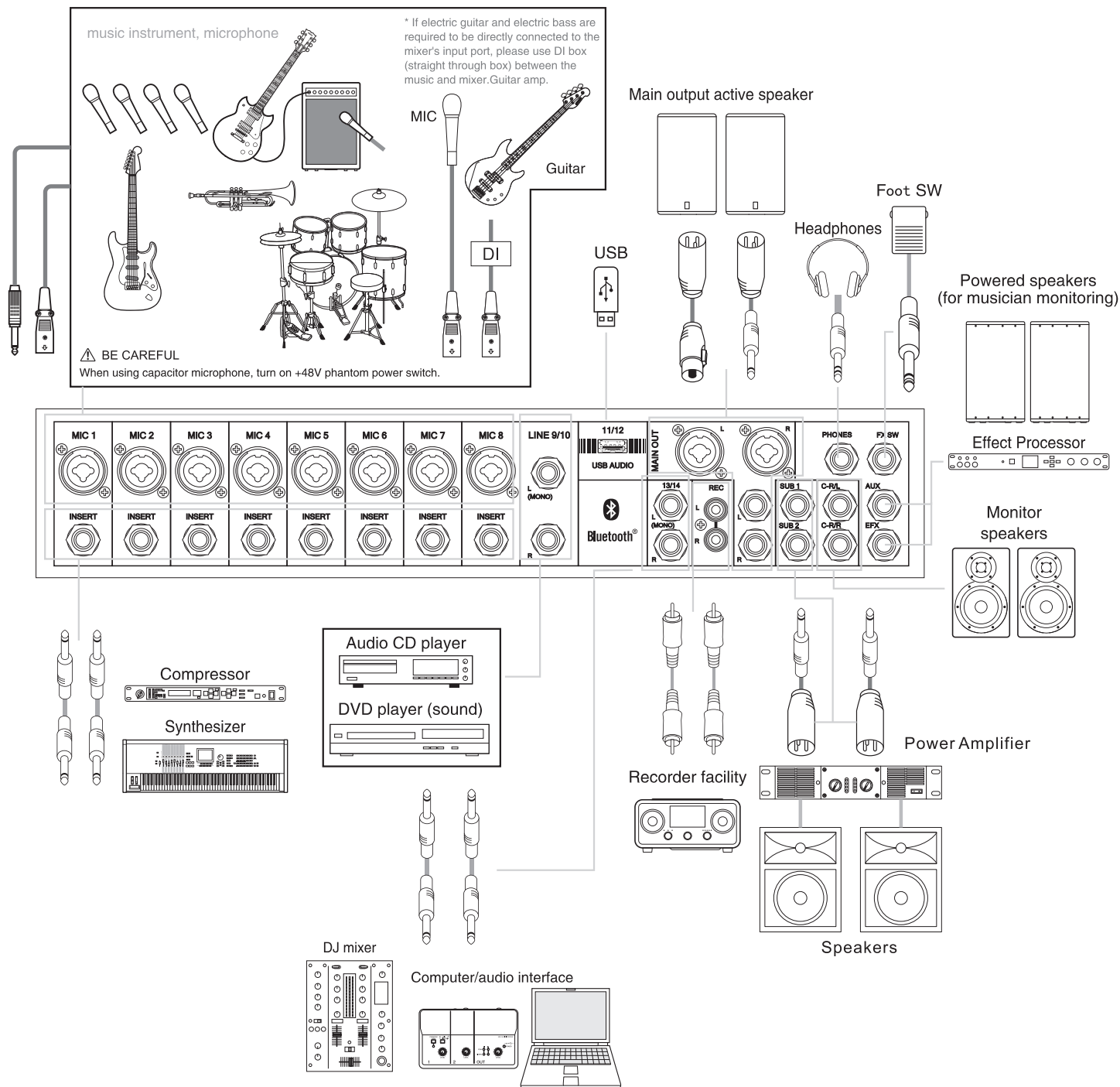

# Panel Function

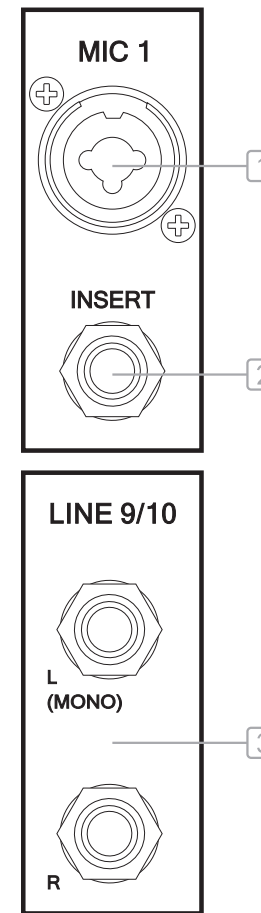

### 1. MIC/LINE/XLR

For connecting to a microphone, an instrument, or an audiodevice. These jacks support both XLR and phone plugs.



### 2. INSERT

INSERT: These are unbalanced TRS (tip=send/out, ring=return/in; sleeve=ground) phone-type bidirectional jacks. You can use these jacks to connect channels to devices such as graphic equalizers, compressors, and noise filters.

#### NOTE

Connection to an INSERT jack requires a special insertion cable as illustrated below.

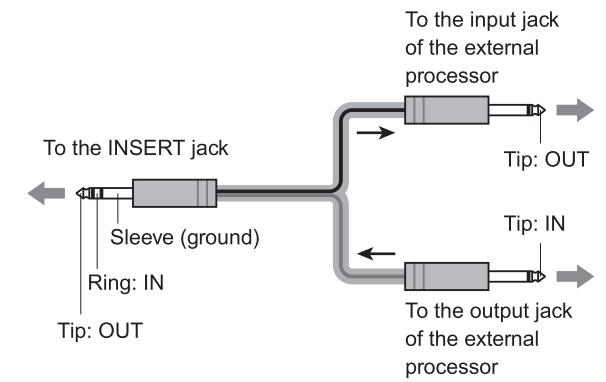

### 3. LINE 9/10 stereo input jacks

Unbalanced phone type line stereo input jacks

### 4. USB

This USB interface, a machine built-in MP3 player and recorder, support format: MP3, WAV, WMA

#### ■ flash memory capacity and format

USB flash operation has been proven to be compatible with up to 64GB flash. (there is no guarantee that it will work with all types of USB flash memory.) Support for FAT16 and FAT32 formats

#### ■ Avoid accidental deletion

Some USB flash devices have protection Settings to prevent data from being accidentally deleted. If your flash device contains important data, it is strongly recommended that you use write protection Settings to prevent data from being accidentally deleted.

### 5. LINE

For connecting to line-level devices such as an electric keyboard or an audio device. Use the [L/MONO] jack on channel 2 for instruments, etc. with mono input. In this case, the sound input to the [L/MONO] jack is output from both the L channel and R channel on the mixer.

### 6. REC

Rec output: Only TAPE channels use unbalanced RCA interface (TAPE INPUT) to connect stereo line signals, such as TAPE recorder, CD player, MP3 player, TV sound, etc.

### 7. SUB 1-2

These impedance-balanced 1/4"TRS jacks output the SUB 1-2 signals. Use these jacks to connect to the inputs of a multi-track recorder, external mixer, or similar device.

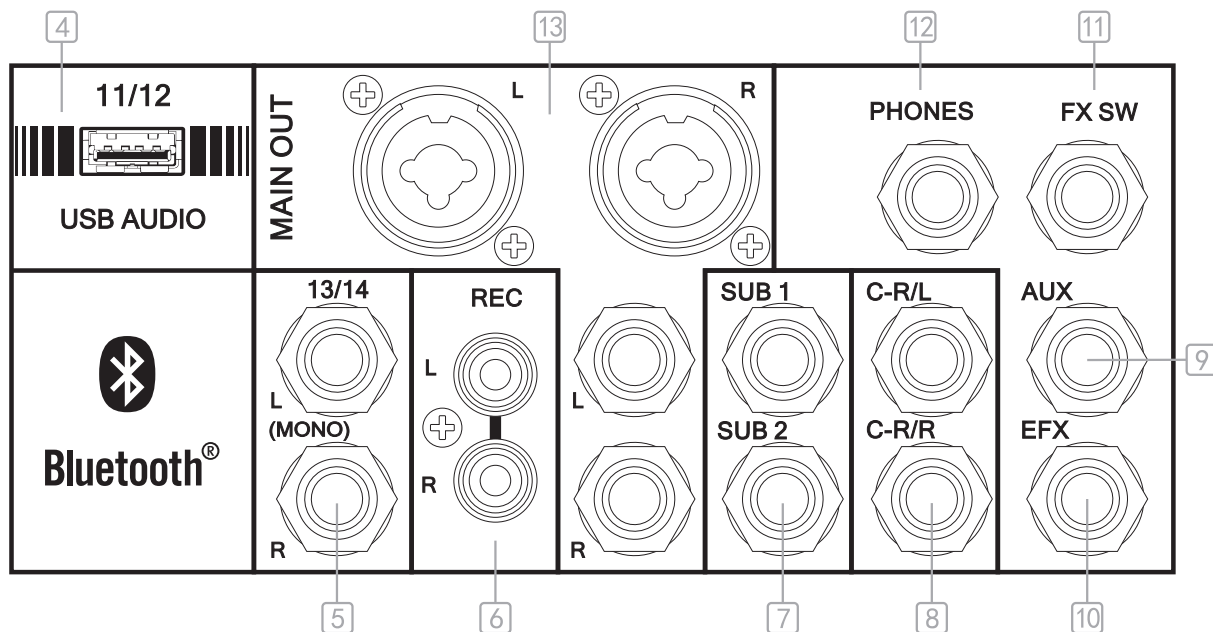

### 8.CR OUT ( L, R )

These are impedance-balanced 1/4" TRS phone output jacks that you connect to your monitor system. These jacks output the signal before or after the faders for the various buses. The SOLO indicators in each section indicate which signal is being output.

#### NOTE

The SOLO switch has priority. To before monitor the post-fader signal, make sure to turn off all SOLO switches.

### 9/10.AUX / EFX

You use these jacks, for example, to connect to an external effect device or a stage/studio monitoring system.

These are impedance-balanced\* phone-type output jacks.

■ Impedance-balanced

Since the hot and cold terminals of impedance-balanced output jacks have the same impedance, these output jacks are less affected by induced noise.

### 11.FX SW

Connect a foot switch to phone type input jack. An optional foot switch can be used to toggle the FX ON and OFF.

### 12.PHONES

For connecting headphones. The socket supports stereo phone plug. If you need to connect headsets or earplugs with mini plugs, please use a switch device to connect.

### 13.MAIN OUT

Here are two main output interfaces: the convex XLR jacks provide balanced circuit information; The 1/4" TRS jack provides a balanced or unbalanced signal.

Each xlr jack is parallel to its 1/4" trs jack, and the load phase Same signal.

This represents the last part of the entire mixing chain, connecting these jacks to you Main power on, active speaker, or a series of effect processors to make your mixing signal real The entity appears.

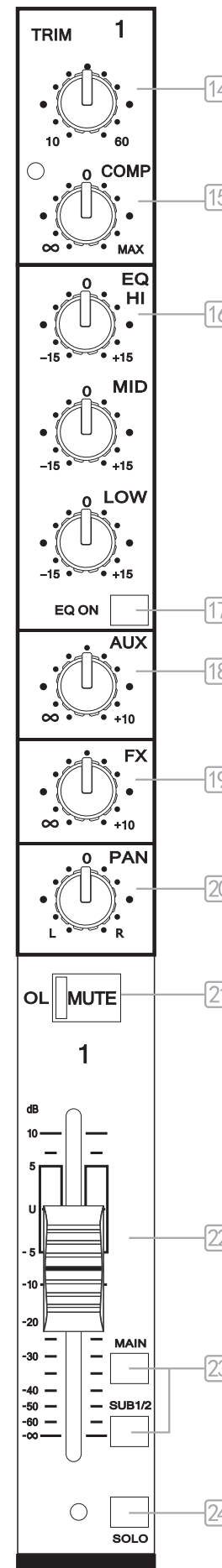

### 14.GAIN

Sets the volume of the microphone or line input signal provided to this channel. The GAIN knob is used to adjust the sensitivity of the microphone and the input signal of the circuit. This allows external signals to be adjusted to the desired internal control level.

### 15.COMP

Adjusts the amount of compression applied to the channel. As the knob is turned to the right the compression ratio increases while the output gain is automatically adjusted accordingly. The result is smoother, more even dynamics because louder signals are attenuated while the overall levels are boosted. The COMP indicator will light when the compressor operates.

#### NOTE

Avoid setting the compression too high, as the higher average output level that results may lead to feedback.

### 16.EQ

#### 1. High

Control the high frequency tone of each channel, Always set this control to the 12 o'clock position, but you can control the high frequency tone according to the speaker, the conditions of listening position and listener's taste, Clockwise rotation of the control increases level.

#### 2. MID

This has a function which controls the middle frequency tone of each channel. Always set this control to the 12 o'clock position, but you can control the middle frequency tone according to the speaker, the conditions of listening position and listener's taste. Clockwise rotation of the control increase the level, and vice versa.

#### 3. LOW

This has a function which controls the middle frequency tone of each channel. Always set this control to the 12 o'clock position, but you can control the middle frequency tone according to the speaker, the conditions of listening position and listener's taste. Clockwise rotation of the control increase the level, and vice versa.

### 17. EQ ON

This button is to let the signal entering the channel add EQ effect.

When the key is pressed, the EQ function will not have an effect on the signal. When the key up, the signal is controlled by EQ to produce the corresponding effect. In this way, you can compare the effect of EQ with that of no Eq.

### 18. AUX

The knob is used to control the size of the auxiliary sending signal of this channel, which is sent to the outside via the AUX SEND knob of the main control Equipment, such as effectors.

These controls have two functions:

- 1.The level used to control the effect, such as the reverberation effect of an external effect processing device loaded on the input signal.
- 2.set up independent remixes of music in the studio or on the stage.(the output signal is after the push)

### 19.FX

These knobs take advantage of each channel's signal sent to the in-machine effect after processing and return to the stereo main channel. Channel fader, mute and other channel controls affect the effect output, but the sound phase adjustment does not (effect assist is after the push).

### 20.PAN

The pan control sends continuously variable amounts of the post fader signal to either the left or right main busses. In the center position equal amounts of signal are sent to the left and right busses.

### 21.MUTE(OL light)

Press this switch to mute the channel.

Useful for switching channels and isolating or pre-adjusting channel levels for currently unused channels.

Used to determine the level of the input signal in the mix and to indicate the visible channel level.

- this switch is set to be on or off to listen to the channel pusher through the PHONES socket.
- close all unused channels to reduce noise.

### OL light

Lights red when the channel's post-equalizer signal level reaches 3dB before clipping.

Note:The OL distortion light is displayed only when the mute button is not pressed.

## 22.CHANNEL FADER

Used to adjust the level of the channel signal.

Note:To minimize noise, adjust the fader on unused channels to a minimum.

## 23.MAIN and SUB1/2 Button

Press the switch ( ) to output the channel signal to the corresponding SUB marshalling or MAIN bus.

- switch SUB 1-2: assign channel signals to sub 1-2 marshalling (bus).
- MAIN switch: allocates channel signals to the MAIN L and R buses.

Note: to send signals to each bus, turn on the MUTE switch

## 24.[SOLO]

Monitor button SOLO: the monitor before the putter attenuation,after pressing,LED light is lit, plug in with the headset The headphone jack of the mixer can hear the sound signal in front of the driver.

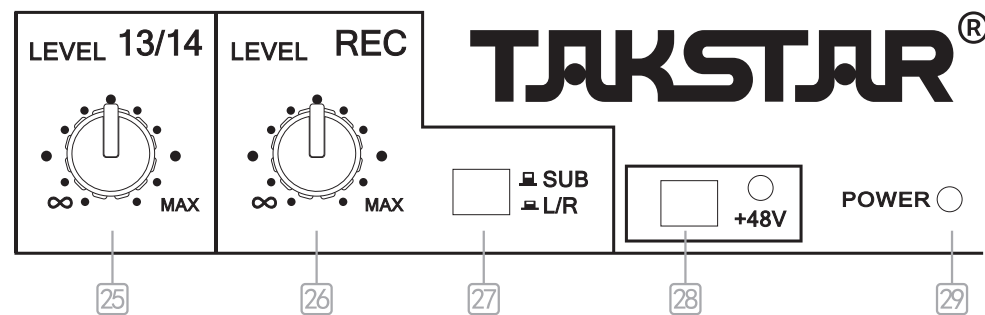

## 25.13/14 LEVEL

Used to adjust the level of the channel signal.

Note: To minimize noise, adjust the knobs on unused channels to a minimum.

## 26.REC LEVEL

Adjust the recording output signal level.

## 27.SUB / L、 R Conversion

Use to switch the SUB / MAIN recording signals.

## 28.+48V LED and PHANTOM

When this switch is turned on ( ), the [+48V] LED lights and DC +48 V phantom power is supplied to the XLR plug on MIC/LINE input jack. Turn this switch on when using a phantompowered condenser microphone.

### NOTICE

Be sure to leave this switch off ( ) if you do not need phantom power. Follow the important precautions below, in order to prevent noise and possible damage to external devices as well as the mixer if you turn this switch on ( ).

1. Be sure to leave this switch off ( ) when you connect a device that does not support phantom power to channel 1.
2. Make sure to turn this switch off ( ) when connecting/disconnecting a cable to/from channel 1.
3. Slide the fader on channel 1 to minimum before turning this switch on ( ) / off ( ).

## 29.POWER LED

The indicator on the mixer will light up when the POWER switch is turned on



### WARNING:

- Do not remove the ground pin of the plug.
- Use in strict accordance with the labeled voltage of the product.
- Rapidly turning the unit on and off in succession can cause it to malfunction. After turning the unit off, wait for at least 6 seconds before turning it on again.
- Note that the trace current continues to flow even while the switch is in the off position. If you do not plan to use the mixer for a while, be sure to unplug the power cord from the wall outlet.

■■■■ USB\SD\BT PLAY ■■■■

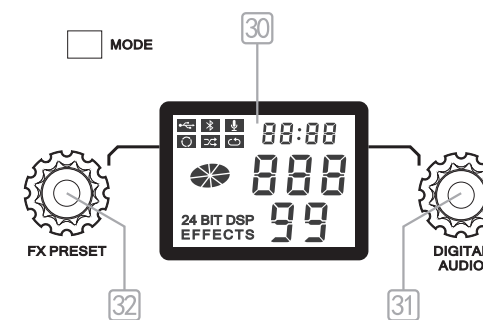

## 31. DIGITAL AUDIO

### 1.DISPLAY

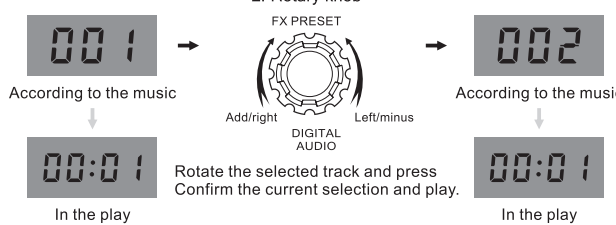

## 32. FX PRESET

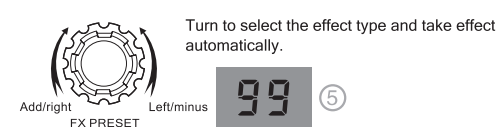

## 30.DISPLAY

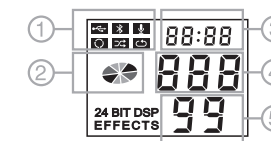

- 1.Function Display
- 2.Display the running status or bluetooth connection status
- 3.song time display
- 4.song number display
- 5.effect types(please refer to the list of effects on the right)

### DIGITAL EFFECTS

01-03 Ambience	57-60 Slap Rev
04-06 Spring	61-68 Echo+rev
07-16 Room	69-74 Chorus
17-26 Plate	75-80 Flanger
27-36 Hall	81-86 Delay+chorus
37-52 Echo	87-92 Rev+chorus
53-56 Pingpong	93-99 Ktv

### Operational control instructions

- A、MODE( touch button): short press: pre-selected mode, corresponding mode icon flicker display, followed by usb flash disk, Bluetooth, recording, sequential play, random play, single loop (short press DIGITAL AUDIO to confirm the switch).
- B、MODE (touch the button lightly) : Long press:
  1. In the recording mode, when the recording is stopped, you can enter the recording play.
  2. In the non-recording mode, you can quickly the recording play.
- C、DIGITAL AUDIO (encoder keys) : Short Press
  1. Control operation or pause (including playing and recording).
  2. When the mode icon flashes, confirm to switch to the current mode of flashing display.
  3. Rotate the encoder to the pre-selected playlist to confirm playing the current corresponding song.
- D、DIGITAL AUDIO (encoder keys) : Long press
  1. Control stop (including playing and recording).
  2. When the recording has stopped, you can enter the recording file mode.
  3. Disconnect the current Bluetooth connection in Bluetooth mode.
- E、Encoder
  1. Pre-select the tracks to play when the usb flash disk is playing.
  2. When bluetooth and recording files are played, switch previous song/ next song.
- F、When the recording is played, the usb flash disk and recording icon are also displayed.

## 33.[AUX MASTER] control knob +[SOLO] monitor button

1. Controls the overall level of signals emitted from the AUX output.This auxiliary output is commonly used for power amplifiers to drive stage monitors so that the singer can hear himself on the amplified instrument, or for headphone amplifiers so that the singer is recording without the microphone receive the monitoring signal.
2. When SOLO monitoring button is pressed, the light will light up.You can hear the sound signal of the connected [AUX] interface device from the monitor, the monitor speaker and the monitor earphone.

## 34.[EFX] Knob +[SOLO] Monitoring Button

1. Control the overall level of the signal emitted from the EFX output.This is usually used to control the volume of a signal connected to an external effector.
2. When SOLO monitoring button is pressed, the light will light up.From the monitor, listening speaker, listening earphone to hear the external effects of the interface [EFX] sound signal.

## 35.CONTROL ROOM/PHONE knob+ SUB/L、 R Switch

- 1.CONTROL ROOM/PHONE: Adjust the output signal to the monitor speaker/monitor earphone.
- 2.SUB/L、 R Switch: The input signal is sent to the listening speaker/listening headset by switching the key to select the main output or Headphones monitoring for output.

## 36. METERS

The left and right level meters of the mixer are composed of two columns of 12 led lamps, led each has three colors to refer to Show the range of the level.

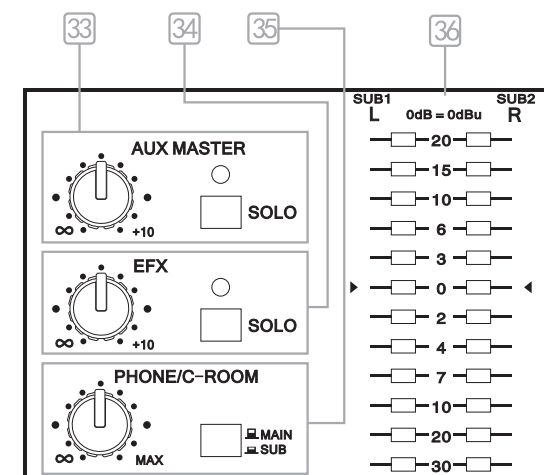

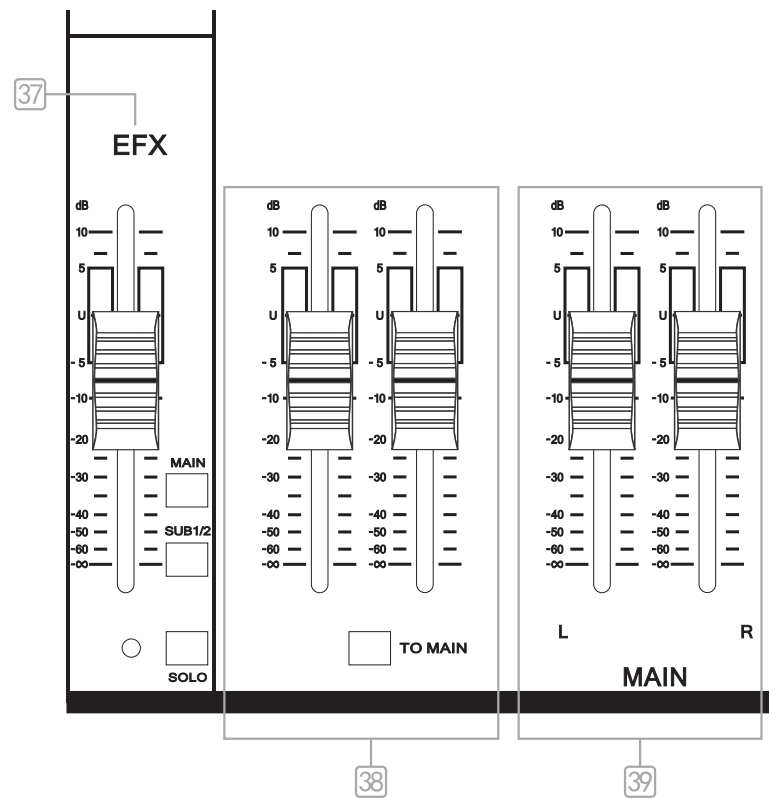

### 37. EFX FADER

Using by this control, you can adjust signal level of echo repeat & exterior effect.

### 38. SUB Fader

This fader controls the level of the marshalling signal, from "off" to "U" unified gain, and then to 10 db The additional gain.

### 39.MAIN FADER

These pushers control the level of the main mixer and affect the level meter and the main line level output. You can control what the audience hears and make sure there are no problems. If there is a problem, please adjust carefully to see if the level meter is overloaded and ensure that the output level is satisfactory to the audience.



The "0" mark is a unit gain, which increases the extra gain 10 dB, Additional gains can be seen here. The mode of level control is very stereoscopic and intuitive, and can be adjusted at the same time. When you want the sound to disappear well at the end of the performance and song, push the push low at the end.

## Back panel function

### Backside of Mixer

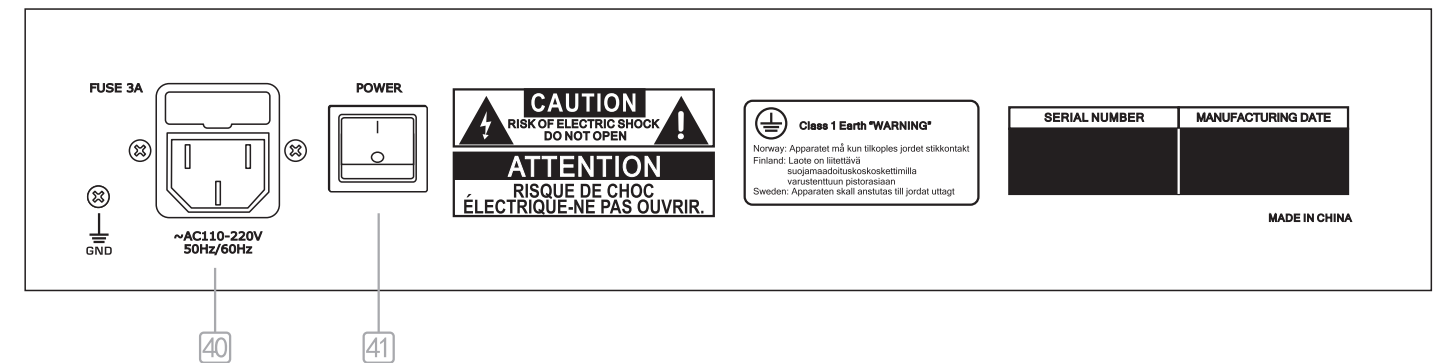

### 40.AC Jack

Standard iec power interface, if the power line provided by this mixer, can also use professional video recorder, musical instruments, computer three-hole iec wire connection.

### 41.POWER Switch

Turns power to the unit on or off. Press the switch to the "I" position to turn on the power. Press the switch to the "O" position to turn off the power.

Note :1. Switching between starting and shutting down continuously and quickly will cause damage to the equipment. Do not try.

The correct way should be to set the power to standby, please wait about 6 seconds before turning on again.

2. Even if the switch is in standby (O) state, a small amount of current will enter the device.If you do not use the device for a period of time, be sure to pull out the DC power cord

## Specifications

0 dBu=0.775 Vrms, 0 dBV=1 Vrms

If you do not specify all the pushes will be set to the nominal position.(nominal position adjusted to 10 dB below maximum position)

Output impedance (Rs) of the signal generator =100 ohm, output load impedance =100k ohm (TRS phone output)

GAIN (0dBu)	INPUT	OUTPUT	CHANNEL		STEREO	RETURN
			MIC	LINE	LINE	
	GAIN (0dBu)		10~60	-10~40	-20~20	
AUX		0dB(PRE)				
		0dB ( POST )	10	-10	-22	
		MAX(POST)	81	61	33	
MONITOR OUT		MAX ( ALL MAX )	78	64	43	40
		0dB(GAIN Control at MIN)	5	-16	9	15
PHONES OUT		MAX ( ALL MAX )	84	61	50	40
		0dB(GAIN Control at MIN)	10	0	15	15
GROUP OUT		MAX ( ALL MAX )	56	67	46	
		0dB(GAIN Control at MIN)	15	-5	17	
STEREO OUT		MAX ( ALL MAX )	86	67	46	19
		0dB(GAIN Control at MIN)	15	-5	17	0
CH INSERT OUT		MAX ( ALL MAX )	60	44		
		0dB(GAIN Control at MIN)	11	-13		
	REC OUT	MAX	75	60	38	
TH-010 Signal to Noise Ratio		STEREO OUT	80	65	85	
		PHONES OUT	79	66	86	
TH-014 Signal to Noise Ratio		STEREO OUT	85	70	90	
		PHONES OUT	85	75	90	
Noise (Control at MIN)		PHONES OUT (Fader at 0dB)				-90
		STEREO OUT(Fader at 0dB)				-73
		TH-010 STEREO OUT (Fader at MIN)				-87
		TH-014 STEREO OUT (Fader at MIN)				-90
		CH INSERT OUT				-95

The contents of this manual are the latest technical specifications at the time of printing.As the product will continue to improve, the specifications in this manual may not be in accordance with your product specifications. Please go to the website to download the latest version of the manual.Technical specifications, equipment or accessories may vary from place to place, so please contact and confirm with local distributor.

## ■ Safety warnings

In order to avoid personal injury or property loss caused by electric shock, high temperature, fire, radiation, explosion, mechanical hazard and improper use, please read carefully and observe the following matters when using this product:

1. When using the product, please confirm whether the connected device matches the power of the product and reasonably adjust the volume. Do not use the product for a long time in excess of the power and high volume of the product, so as to avoid abnormal product and hearing damage;
2. Use if found abnormal (such as smoke, odor, etc.), please immediately turn off the power switch and unplug the power plug, and then send the product to dealers for maintenance;
3. The product and accessories should be placed in a dry and ventilated place indoors, and should not be stored in a humid and dusty environment for a long time. During use, avoid being near the fire source, rain, water, excessive collision, throwing, vibrating the machine and covering the ventilation hole, so as not to damage its function;
4. If the product needs to be fixed on the wall or ceiling, please ensure that it is fixed in place to prevent the product from falling risk due to insufficient fixed strength;
5. When using the product, please comply with the relevant safety regulations. Please do not use the product when it is expressly prohibited by laws and regulations to avoid accidents.
6. Please do not disassemble or repair the machine by yourself to prevent personal injury. If there is any problem or service demand, please contact the local dealer for follow-up treatment.



Only suitable for use in areas below 2000 meters



Only suitable for use in non-tropical climates

### 注意事项:

1. 本单为保修凭证, 请用户妥善保管, 如有遗失, 恕不保修或退换。
2. 保修期限限制: 购买之日起十二个月内。
3. 除了不可抗力事件损坏外, 由本公司负责, 免费维修。
4. 如属保管不善或使用不当造成的损坏, 维修点将酌情收费。
5. 擅自拆卸维修者, 不予保修。
6. 以上保修条款仅限于中国市场适用 (不含港澳台地区)。

## 产品服务保证书

姓名: \_\_\_\_\_ 电话: \_\_\_\_\_ 地址: \_\_\_\_\_

商品: \_\_\_\_\_ 型号: \_\_\_\_\_ 购买日期: \_\_\_\_\_ 年 \_\_\_\_ 月 \_\_\_\_ 日

维修记录栏 (由维修员填写)	维修员签名	日期

◆广东得胜电子有限公司 ◆电话: 400-6828-333 ◆地址: 广东省惠州市博罗县龙溪街道富康一路2号